

# COLORIST™ PANEL 36Qa

---

## User Manual

---

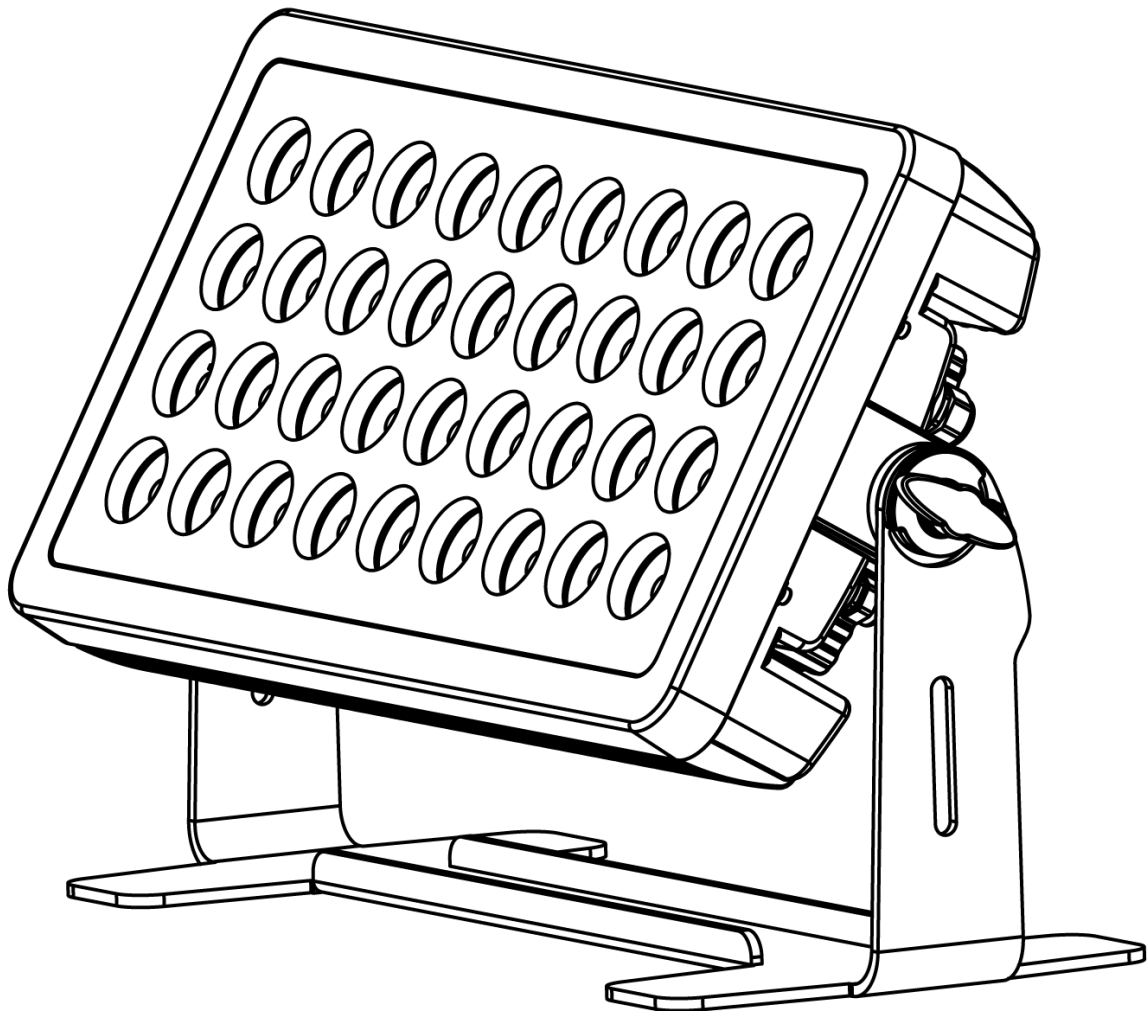

## Edition Notes

The Colorist™ Panel 36Qa User Manual Rev. 2 covers the description, safety precautions, installation, programming, operation, and maintenance of the Colorist™ Panel 36Qa. ILUMINARC® released this edition of the Colorist™ Panel 36Qa User Manual Rev. 2 in February 2015. Read the guide that shipped with the Colorist™ Panel 36Qa and this User Manual before installing, operating, or maintaining this product.

### Trademarks

The ILUMINARC® logo, the ILUMINARC® name and all other trademarks in this document related to services or products by ILUMINARC® are trademarks owned or licensed by ILUMINARC®, its affiliates or subsidiaries. Any other product names, logos, brands, company names, trademarks featured or referred to within this document are the property of their respective trademark holders.

### Manual Usage

ILUMINARC® authorizes its customers to download and print this manual for professional information purposes only. ILUMINARC® expressly prohibits the usage, copy, storage, distribution, modification, or printing of this manual or its content for any other purpose without its written consent.

### Document Printing

For better results, print this document in color, on letter size paper (8.5 x 11 in), double-sided. If using A4 paper (210 x 297 mm), configure your printer to scale the content of this document to A4 paper.

### Disclaimer

ILUMINARC® believes that the information contained in this manual is accurate in all respects. However, ILUMINARC® assumes no responsibility for any error or omissions in this document. ILUMINARC® reserves the right to revise this document and to make changes from time to time in the content without obligation of ILUMINARC® to notify any person or company of such revision or changes. ILUMINARC® may issue a revision of this manual or a new edition of it to incorporate such changes. This does not constitute in any way a commitment by ILUMINARC® to make such changes.

### Document Revision

The Colorist™ Panel 36Qa User Manual Rev. 2 supersedes all previous versions of this manual. Discard any older versions of this manual and replace with this version. Go to <http://www.iluminarc.com/> for the latest version.

### Copyright Notice

The entire content of this document, except where applicable and unless otherwise noted, is solely owned by ILUMINARC®, a wholly owned trademark of Chauvet & Sons, Inc.

© Copyright 2015 ILUMINARC®.

All rights reserved.

Electronically published by ILUMINARC® in the United States of America.

Author	Date	Editor	Date
A. Leon	01/22/15	D. Coupepe	4/24/15

# Table of Contents

- 1. Introduction ..... 1**
  - What Is In The Box ..... 1
  - Unpacking Instructions ..... 1
    - Claims .....1
  - Text Conventions ..... 1
  - Safety Notes ..... 2
    - Personal Safety .....2
    - Mounting and Installation .....2
    - Power and Wiring .....2
    - Operation .....2
- 2. Product Description ..... 3**
  - Features ..... 3
  - Product Overview ..... 4
  - Product Dimensions ..... 5
- 3. Installation ..... 6**
  - Mounting ..... 6
    - Orientation .....6
    - Installation .....6
      - Procedure .....6
  - AC Power ..... 7
    - Power Consumption .....7
    - AC Plug .....7
    - Power Linking .....7
  - DMX Linking ..... 8
    - DMX Connection .....8
    - IP65 DMX Cable Table .....8
    - DMX Personality .....8
  - DMX Controller ..... 9
- 4. Operation ..... 10**
  - Control Panel Description ..... 10
  - Control Options ..... 10
  - DMX Programming ..... 10
    - Static Colors .....10
    - Auto Play .....10
    - Custom Color .....10
      - Temperature .....11
      - Passcode .....11
    - Dimmer .....11
  - Menu Map ..... 12
  - DMX Values ..... 13

---

<b>5. Technical Information .....</b>	<b>14</b>
Product Maintenance .....	14
Product Repairs .....	14
Photometrics .....	15
LED Disclaimer .....	16
LED Life .....	16
LED Binning .....	16
Color Rendering Index (CRI) .....	16
Return Procedure .....	17
<b>Contact Us .....</b>	<b>17</b>
<b>6. Technical Specifications .....</b>	<b>19</b>

# 1. Introduction



Critical installation, configuration, or operation information. Failure to comply with this information may render the product partially or completely inoperative, damage third-party equipment, or cause harm to the user



Important installation or configuration information. Failure to comply with this information may prevent the product from functioning correctly.



Useful information.



The term "DMX" used throughout this document refers to the USITT DMX512-A transmission protocol.

## What Is In The Box

- Colorist™ Panel 36Qa
- IP65 Power Input/Output Cords with adapters
- IP65 Data Input/Output Cords with adapters
- Warranty Card
- Quick Reference Guide

## Unpacking Instructions

Immediately upon receiving a product from ILUMINARC®, carefully unpack the carton. Check the contents of the box to ensure that all parts are present and that they are in good condition.

## Claims

The carrier is responsible for any damage incurred during shipping. Therefore, if the received merchandise appears to have been damaged during shipping, the customer must submit the damage report and any related claims to the carrier, not ILUMINARC®. The customer must submit the report upon receipt of the damaged merchandise. Failure to do so in a timely manner may invalidate the customer's claim with the carrier.

For other issues such as missing components or parts, damage not related to shipping, or concealed damage, the customer must make claims to ILUMINARC® within 7 days of receiving the merchandise.

## Text Conventions

Convention	Meaning
1–512	A range of values in the text
50/60	A set of mutually exclusive values in the text
<SET>	A button on the product's control panel
<b>Settings</b>	A product function or a menu option
<b>MENU &gt; Settings</b>	A sequence of menu options
<b>1–10</b>	A range of menu values from which to choose in a menu
<b>Yes/No</b>	A set of two mutually exclusive menu options in a menu
<b>ON</b>	A unique value to enter or select in a menu



There are no user-serviceable parts inside this product. Any reference to servicing you may find in this User Manual will only apply to properly certified ILUMINARC® technicians. Do not open the housing or attempt any repairs unless you are certified to do so.



Please refer to all applicable local codes and regulations for the proper installation of this product.



Keep this manual for future consultation. If you sell this product to another user, make sure that they also receive this manual.



In the unlikely event that your Colorist™ Panel 36Qa may require service, please contact ILUMINARC® Technical Support.



Please consult with an Illuminarc Sales Representative on the suitability of this product for your installation. Failure to follow these guidelines or the recommendations of the Illuminarc Sales Representative may result in the product warranty being rendered VOID and any repair cost being the sole responsibility of the buyer.

## Safety Notes

Please read all the following Safety Notes carefully because they include important information on how to install, use, and maintain this product safely.

### Personal Safety

- Avoid direct eye exposure to the light source while the product is on.
- Always disconnect this product from its power source before servicing.
- Always connect this product to a grounded circuit to avoid the risk of electrocution.
- Do not touch this product's housing when operating because it may be very hot.

### Mounting and Installation

- This product is for outdoor use (IP65). All indoor and limited outdoor permanent installations.
- Not for permanent outdoor installation in locations with extreme environmental conditions. This includes, but is not limited to:
  - Exposure to a marine/saline environment (within 3 miles of a saltwater body of water).
  - Where the normal high or low temperatures of the location exceed the temperature ranges in this manual.
  - When mounting outdoors, do not point the product straight down.
  - Locations that are prone to flooding or being buried in snow.
  - Other areas where the product will be subject to extreme radiation or caustic substances.
- CAUTION: When transferring product from extreme temperature environments, (e.g. cold truck to warm humid ballroom) condensation may form on the internal electronics of the product. To avoid causing a failure, allow product to fully acclimate to the surrounding environment before connecting it to power.
- Make sure there are no flammable materials close to this product while it is operating.
- When hanging this product, always secure it to a fastening device using a safety cable (not provided).

### Power and Wiring

- To eliminate unnecessary wear and improve its lifespan, during periods of non-use completely disconnect the product from power via breaker or by unplugging it.
- Always make sure that you are connecting this product to the proper voltage, as per the specifications in this manual or on the product's sticker.
- Never connect this product to a dimmer pack.
- Make sure that the power input cable is not cracked, crimped, or damaged.
- Never disconnect this product by pulling on the power input cable.

### Operation

- The maximum ambient temperature range is -20 °F to 110 °F (-29 °C to 43 °C). Do not operate this product outside these temperatures.
- In case of a serious operating problem, stop using this product immediately!

## 2. Product Description

The Colorist™ Panel 36Qa is an IP65-rated linear wash product that may be used to light a variety of both indoor and outdoor applications.

The Colorist™ Panel 36Qa consists of 36 quad-color RGBA 15 watt LEDs which can be controlled via the control panel or DMX control connections located on the back of the aluminum housing. The power connections are also located on the back of the product.

### Features

- 4-, 6-, or 10-channel RGBA quad-color LED wash product
- Operating personalities:
  - 4-channel: RGBA
  - 6-channel: RGBA, dimmer, strobe
  - 10-channel: RGBA, dimmer, color macro, strobe, auto, speed, dimmer profile
- RGBA color mixing with or without DMX control
- 3 distinct dimming profiles
- Touch sensitive LED display with Passcode protection
- Built-in automated programs via DMX

### Product Overview

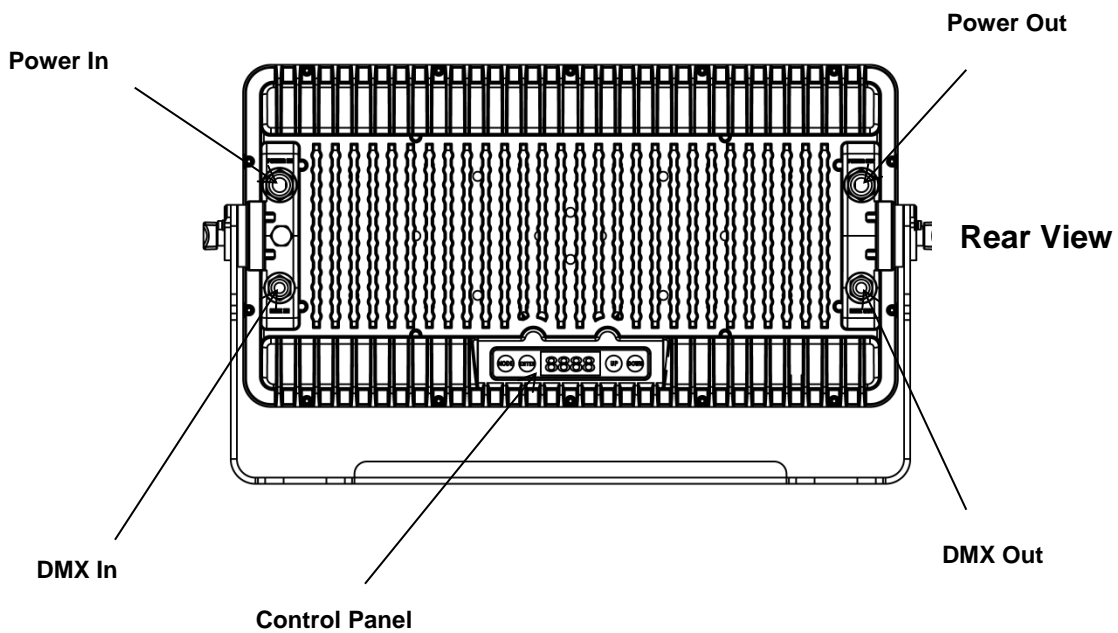
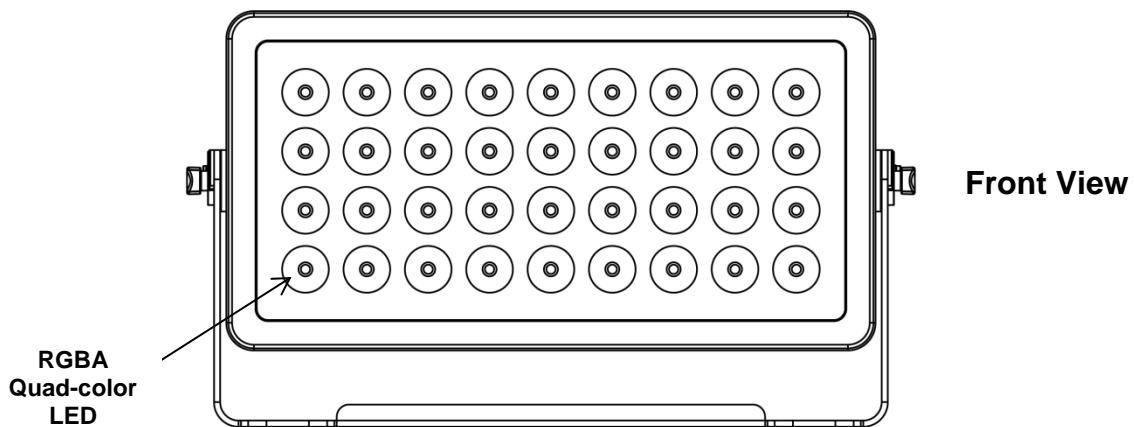
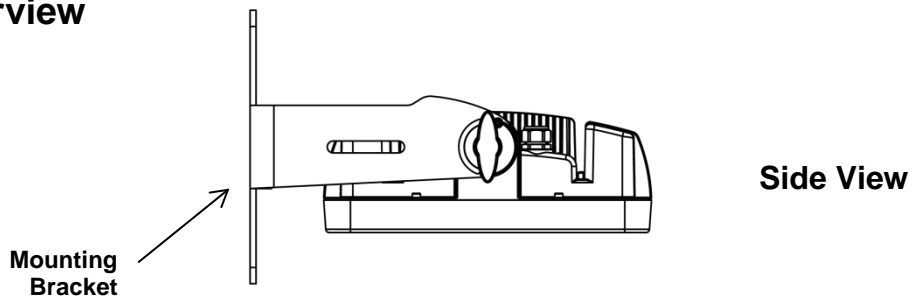



### Product Dimensions

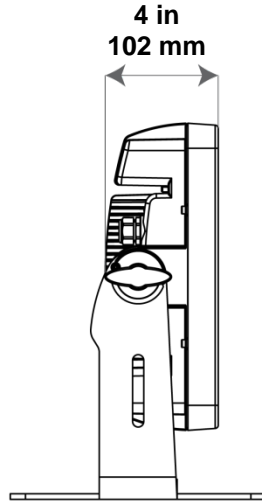

Side View

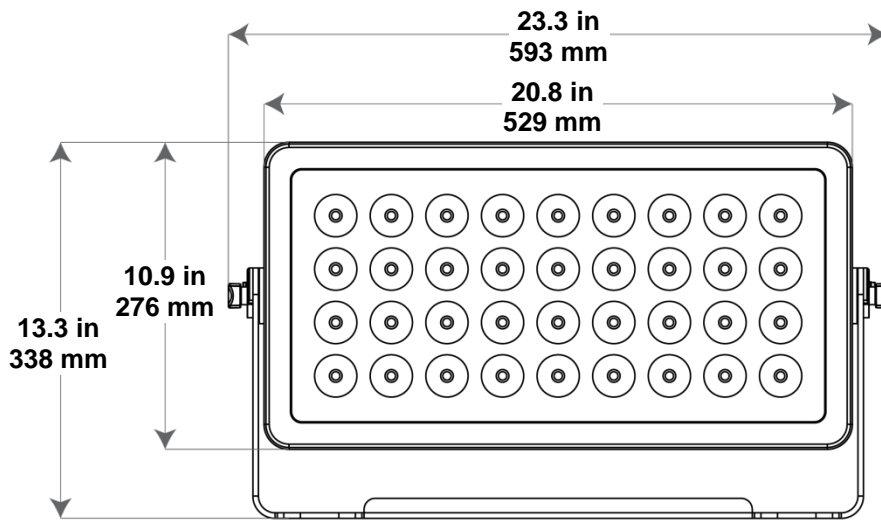

Front View

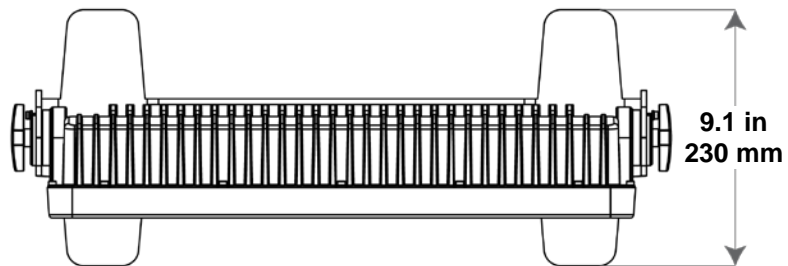

Rear View

### 3. Installation

#### Mounting

Before mounting this product, read and follow the safety recommendations indicated in the [Safety Notes](#).

#### Orientation

Always mount this product in a safe position, making sure there is adequate room for ventilation, configuration, and maintenance.

#### Installation



Make sure to mount this product away from any flammable material as indicated in the [Safety Notes](#).



Not for permanent outdoor installation in locations with extreme environmental conditions.

ILUMINARC® recommends following the general guidelines below when mounting the Colorist™ Panel 36Qa.

- When selecting an installation location, consider ease of access to the product for operation, programming adjustments and routine maintenance.
- Product aperture must not hang between 171° and 189° on the vertical axis in outdoor environments.
- Not for permanent outdoor installation in locations with extreme environmental conditions.
- Make sure the product’s mounting location can support its weight. See the [Technical Specifications](#) for the weight requirement(s) of this product.

#### Procedure



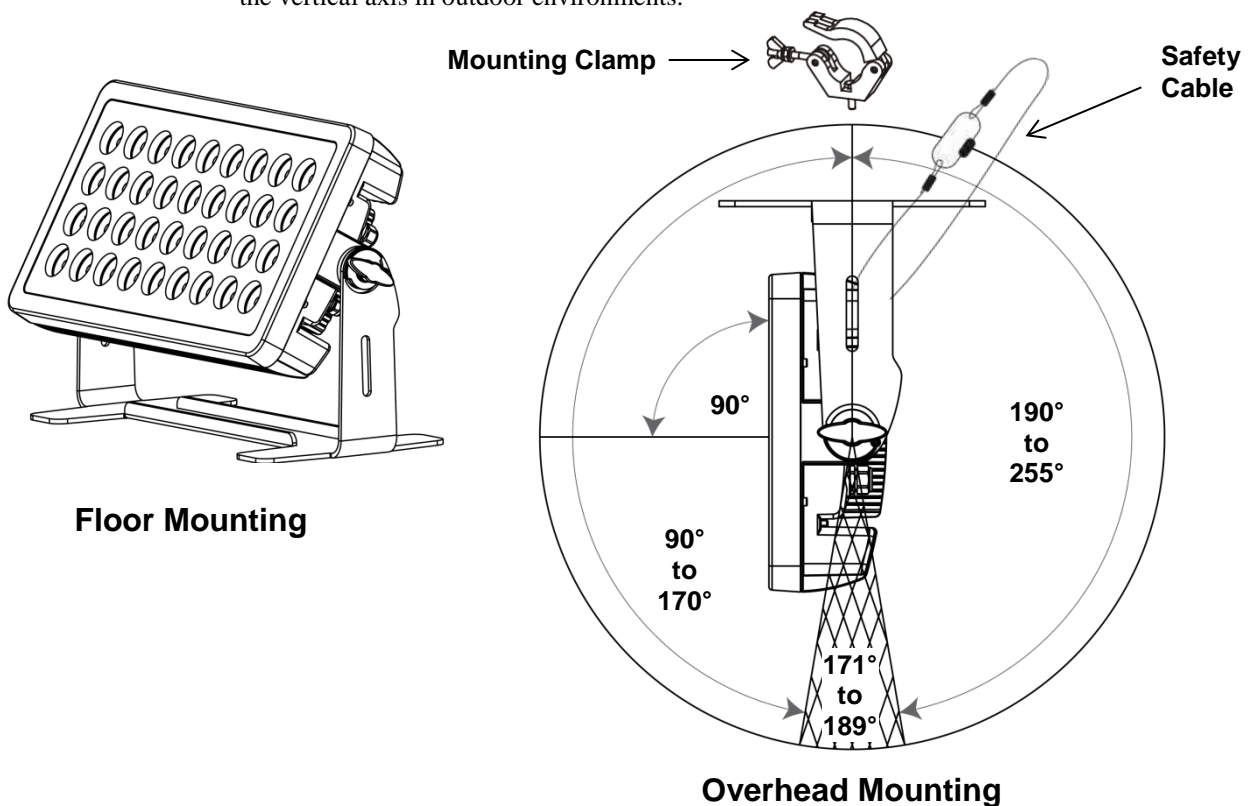

Product aperture must not hang between 171° and 189° on the vertical axis in outdoor environments.

The Colorist™ Panel 36Qa comes with an adjustable floor-mounting bracket that doubles as a hanging bracket to which you can attach a mounting clamp, using the M12 holes in the bottom. This bracket also serves as a floor stand or wall-mount support. You must supply your own clamps and make sure the clamps are capable of supporting the weight of this product. You must use one mounting point per product. Product aperture must not hang between 171° and 189° on the vertical axis in outdoor environments.



 Always connect the Colorist™ Panel 36Qa to a protected circuit with an appropriate electrical ground to avoid the risk of electrocution or fire.

 Never connect the Colorist™ Panel 36Qa to a rheostat (variable resistor) or dimmer circuit, even if the rheostat or dimmer channel serves only as a 0–100% switch.

 Make sure to connect the Colorist™ Panel 36Qa to a power line with the proper voltage and frequency, as per the specifications in this manual or on the product's sticker.

## AC Power

The Colorist™ Panel 36Qa has an auto-ranging power supply that works with an input voltage range of 100–240 VAC, 50/60 Hz.

Make sure that you are connecting this product to the proper voltage, as per the specifications in this User Manual or on the product's sticker.

## Power Consumption

To determine the power requirements for the Colorist™ Panel 36Qa, refer to the label affixed to the side of the product. You may also refer to the [Technical Specifications](#).

The listed current rating indicates the maximum current draw during normal operation.

## AC Plug

The Colorist™ Panel 36Qa comes with an IP65 power input cord terminated with a proprietary IP65 connector and an IP65 to Edison power cord adapter. If the power cord adapter that came with your product has no plug or you need to change the Edison plug, use the table below to wire the new plug..

Connection	Wire (U.S.)	Screw Color (U.S.)	Wire (Europe)	IP65 Pin
AC Live	Black	Yellow or Brass	Brown	1
AC Neutral	White	Silver or Gray	Blue	2
AC Ground	Green/Yellow	Green	Green/Yellow	3

### IP65 Power Connector Pins

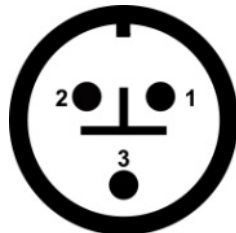

Male

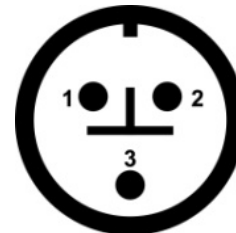

Female

 The listed current rating indicates the maximum current draw during normal operation.

 When connecting the Colorist™ Panel 36Qa to local power, it may be necessary to use the local-to-IP65 adapters supplied with this product.

## Power Linking

The Colorist™ Panel 36Qa supports power linking. You can power link up to 6 products at 120 VAC, 18 products at 208 VAC, or 12 products at 230 VAC. Never exceed these numbers. This product comes with a power input cord. This product does not require additional power linking cables; however, if longer power linking cables are needed, they can be purchased separately.



The Colorist™ Panel 36Qa must be linked using DMX cable in a daisy chain (serial) fashion. To comply with the EIA-485 standard, no more than 32 products should be connected on one daisy chain without using a DMX optically isolated splitter. Doing otherwise may result in deterioration of the digital DMX signal.



USITT recommends limiting the total length of the DMX cable (from the first product/controller to the last product) to 300–455 m (985–1,500 ft).



To connect the Colorist™ Panel 36Qa to your DMX network, it is necessary to use the 3-pin to 5-pin adapters supplied with this product.



When not using the Power Output, DMX Input or DMX Output connectors, you must seal the cable ends with the supplied caps.

## DMX Linking

You may link the Colorist™ Panel 36Qa to a DMX controller using a standard DMX serial connection. If using other DMX products compatible with the Colorist™ Panel 36Qa, you can control each individually with a single DMX controller.

If you are not familiar with the DMX standard, or if you need information about the DMX cables needed to link the Colorist™ Panel 36Qa to a DMX controller, you may download the “DMX Primer” from the ILUMINARC® website at <http://www.iluminarc.com/reports/dmx-primer>.

## DMX Connection

The Colorist™ Panel 36Qa uses a regular DMX data connection for its DMX personalities: **4-CH**, **6-CH**, and **10CH**.

## IP65 DMX Cable Table

Connection	DMX (U.S.)	DMX (Europe)	IP65 Pin
Ground	Shield	Shield	1
Data -	White	Blue	2
Data +	Red	Brown	3

## IP65 DMX Connector Pins

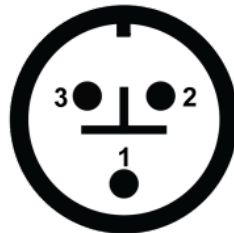

Male

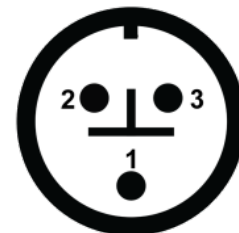

Female

## DMX Personality

The Colorist™ Panel 36Qa uses the standard DMX data connection for its 5 DMX personalities as per the table below. Refer to the [Introduction](#) chapter for a brief description of these personalities. Refer to the [Operation](#) chapter to learn how to configure the Colorist™ Panel 36Qa to work in these personalities. The [DMX Values](#) section provides detailed information regarding the DMX personalities.

DMX Personality	DMX Address
<b>4-CH</b>	509
<b>6-CH</b>	507
<b>10CH</b>	503

### DMX Controller

**i** If you have not configured the DMX starting address and DMX personality for each product, they will all use their default values. This means that all products will operate in unison.

The Colorist™ Panel 36Qa can work with a standard DMX controller. The channel assignments will depend on the chosen DMX personality (see the corresponding [Menu Map](#) section) and the DMX address assigned to each product (see the [Programming](#) section). The figure below illustrates how to connect the DMX controller to the Colorist™ Panel 36Qa.

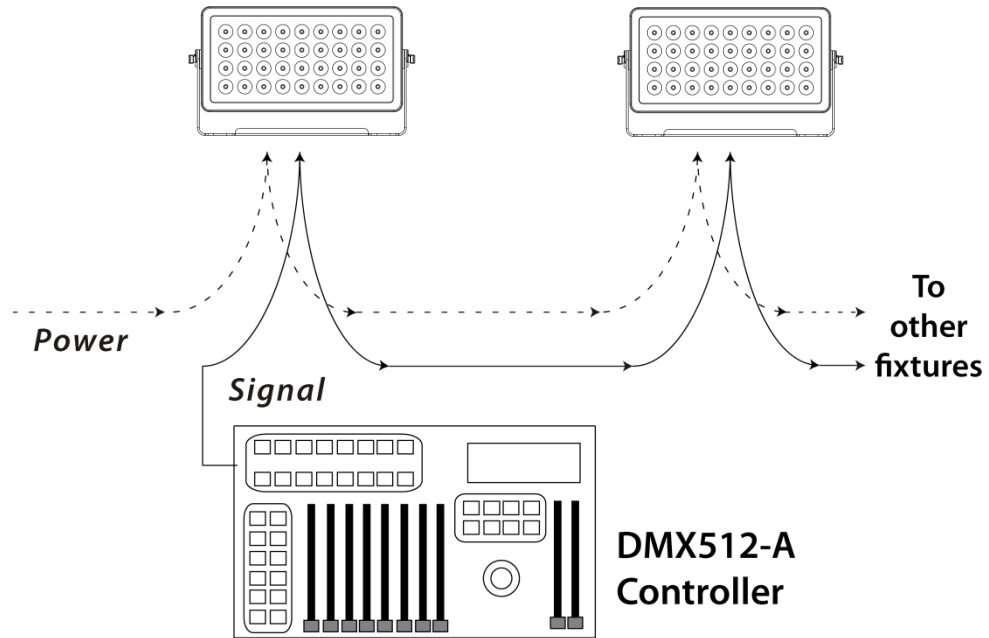

## 4. Operation

### Control Panel Description

Button	Function
<MODE>	Exits from the current menu or function
<ENTER>	Enables the currently displayed menu or sets the currently selected value in to the current function
<UP>	Navigates upwards through the menu list and increases the numeric value when in a function
<DOWN>	Navigates downwards through the menu list and decreases the numeric value when in a function

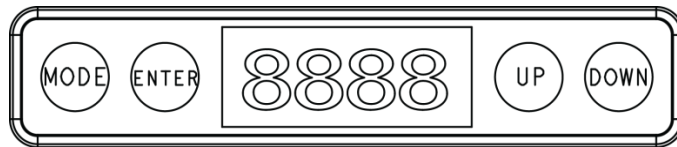

### Control Options

You can set the Colorist™ Panel 36Qa start address in the **001–512** DMX range. This allows for the control of up to 51 products in the 10-channel **10CH** personality.

### DMX Programming

Carry out all the programming procedures indicated below from the control panel. Refer to the [Menu Map](#) to learn how the menu options relate to each other.

Use <ENTER> and <MODE> to change levels in the Menu Map. Use <UP> and <DOWN> to select from among the Menu Map options.

1. From the Main Level select any DMX personality: **4-CH**, **6-CH**, or **53CH**.
2. Go to **d** and select a starting DMX address (**1–512**).

### Static Colors

1. Go to **C--**.
2. Select a color (**C 1–15**).

### Auto Play

1. Go to **P--**.
2. Select an auto program (**P 1–5**).
3. Go to **S--**.
4. Select an auto program speed (**S 1–100**).

### Custom Color

1. Go to **U--**.
2. Select a color (**r**, **g**, **b**, or **A**).
3. Configure the color value (**0–255**).
4. Repeat steps 4 and 5 for the other colors.



**P 01–10** are fully configured programs and cannot be modified.



The Passcode is a default setting and not customizable.



**DIM1** is the fastest dimming curve and **DIM3** is the slowest.

## Temperature

This menu option allows you to see the temperature of the product while it is operating.

1. Go to **teMP**.
2. The products temperature is displayed **XX** (°C).

## Passcode

When **PASS** is active, the product will ask you to enter the passcode (<UP>, <DOWN>, <UP>, and <DOWN>) after 30 seconds of control panel inactivity or upon power up.

1. Go to **PASS**.
2. Select a setting (**ON/OFF**).

## Dimmer

This setting gives the user three different options to simulate the dimming curve of an incandescent lighting product.

1. Go to **dIM**.
2. Select a dimming curve (**OFF** or **dIM1-3**).

### OFF

- Linear RGBA and Master Dimmer

### DIM1-3

- Non-linear RGBA and Master Dimmer

## Menu Map

Main Level	Programming Levels		Description
4-CH	d	1-512	Selects DMX personality and sets the DMX starting address
6-CH			
10CH			
C---	C 1		R (red)
	C 2		G (green)
	C 3		B (blue)
	C 4		A (amber)
	C 5		GB
	C 6		RB
	C 7		RG
	C 8		RGB
	C 9		RA
	C 10		GA
	C 11		BA
	C 12		RGA
	C 13		RBA
	C 14		GBA
	C 15		RGBA
P--	P	1-5	Selects an auto program
S--	S	1-100	Selects the auto program speed (slow to fast)
U---	r	0-255	Combines red, green, blue, and amber to make a custom color (0-100%)
	g		
	b		
	A		
dIM	OFF		Off
	dIM1		Dimming profiles fast (dIM1) to slow (dIM3)
	dIM2		
	dIM3		
teMP	XX		Shows product temperature (°C)
PASS	On		Turns the passcode on or off
	OFF		



**DMX Values**

10CH	Channel	Function	Value	Percent/Setting
	1	Dimmer	000 ó 255	0–100%
	2	Red	000 ó 255	0–100%
	3	Green	000 ó 255	0–100%
	4	Blue	000 ó 255	0–100%
	5	Amber	000 ó 255	0–100%
	6	Strobe	000 ó 010 011 ó 255	No function Slow to fast
	7	Color Macro + White Balance	000 ó 010 011 ó 030 031 ó 050 051 ó 070 071 ó 090 091 ó 110 111 ó 130 131 ó 150 151 ó 170 171 ó 200 201 ó 205 206 ó 210 211 ó 215 216 ó 220 221 ó 225 226 ó 230 231 ó 235 236 ó 240 241 ó 245 246 ó 250 251 ó 255	No function R: 100%      G: 0–100%      B: 0 R: 100%–0    G: 100%            B: 0 R: 0            G: 100%            B: 0–100% R: 0            G: 100%–0        B: 100% R: 0–100%    G: 0                B: 100% R: 100%       G: 0                B: 100%–0 R: 100%       G: 0–100%        B: 0–100% R: 100%–0    G: 100%–0        B: 100% RGBA: 100% White 1 White 2 White 3 White 4 White 5 White 6 White 7 White 8 White 9 White 10 White 11
	8	Auto Programs	000 ó 051 052 ó 101 102 ó 152 153 ó 203 204 ó 254 255	No function Auto Program 1 Auto Program 2 Auto Program 3 Auto Program 4 Auto Program 5
	9	Auto Speed	000 ó 255	Auto program speed (slow to fast)
	10	Dimming Profiles	000 ó 051 052 ó 101 102 ó 152 153 ó 203 204 ó 255	Preset dimmer speed from display menu Dimmer profile off (linear dimmer) Nonlinear dimming profile 1 (fastest) Nonlinear dimming profile 2 Nonlinear dimming profile 3 (slowest)
6-CH	Channel	Function	Value	Percent/Setting
	1	Dimmer	000 ó 255	0–100%
	2	Red	000 ó 255	0–100%
	3	Green	000 ó 255	0–100%
	4	Blue	000 ó 255	0–100%
	5	Amber	000 ó 255	0–100%
	6	Strobe	000 ó 010 011 ó 255	No function Slow to fast
4-CH	Channel	Function	Value	Percent/Setting
	1	Red	000 ó 255	0–100%
	2	Green	000 ó 255	0–100%
	3	Blue	000 ó 255	0–100%
	4	Amber	000 ó 255	0–100%

## 5. Technical Information

### Product Maintenance

To maintain optimum performance and minimize wear, clean the products frequently. Usage and environment are contributing factors in determining the cleaning frequency. As a general guideline, products should be cleaned at least twice a month. Dust build-up reduces light output, performance, and can cause overheating. This can lead to reduced light source life.

For products containing external optical lenses, clean them periodically to optimize light output. The cleaning frequency depends on the environment in which the product operates. Damp, smoky, or particularly dirty surrounding can cause greater accumulation of dirt on the product's optics, requiring more frequent cleaning.

To clean a product:

1. Unplug the product from power.
2. Wait until the product is at room temperature.
3. Use a vacuum (or dry compressed air) and a soft brush to remove dust collected on the external vents and reachable internal components.
4. Clean all external glass optics and glass surfaces with a mild solution of glass cleaner or isopropyl alcohol, and a soft, lint-free cotton cloth or lens-cleaning tissue.
5. Clean all plastic surfaces, including LED lenses, with mild soapy water and a soft, lint-free cotton cloth or a lens-cleaning tissue.
6. Apply the solution directly to the cloth or tissue and wipe any dirt and grime to the outside edge of the lens.
7. Gently polish the external glass surfaces until they are free of haze and lint.



Always dry the external optics and glass surfaces carefully after cleaning them.



If you still experience technical problems, contact

[ILUMINARC® Technical Support](#).

### Product Repairs

ILUMINARC® strongly advises you against attempting any repairs to this product unless you are an authorized ILUMINARC® technician.

## Photometrics

**Filename:** ColoristLine12Qa\_IESNA2002

**Manufacturer:** ILUMINARC

**Luminaire:** Colorist Line 12Qa

**Lamp:** LED

**Lamp Output:** 1 lamp, rated Lumens/lamp: 563.5

**Max Candela:** 18,243.4 at Horizontal: 0°, Vertical: 0°

**Input Wattage:** 102.5

**Luminous Opening:** Circular (Dia: 0.28M)

**Test:** ALL

**Test Date:** 2014-03-24

**Test Lab:** ILUMINARC R&D Optics Laboratory

**Photometry :** Type B

**Cutoff Class:** Full Cutoff

**Nema Type:** 3 X 3

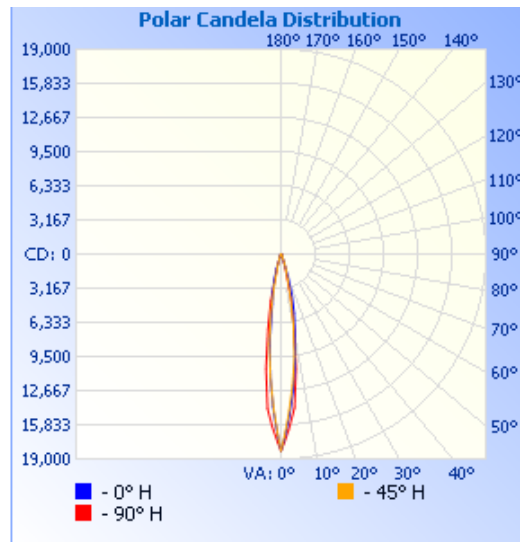

### Flood Summary

	Efficiency	Lumens	Horizontal Spread	Vertical Spread
Field (10%):	263.4%	1,484.2	30.4	34.6
Beam (50%):	73.1%	411.8	17.1	15
<b>Total:</b>	<b>321.3%</b>	<b>1,810.6</b>		

### Illuminance at a Distance

	Center Beam LUX	Beam Width	
1.67M	<b>6,563 LUX</b>	<b>0.44 M</b>	<b>0.50 M</b>
3.33M	<b>1,641 LUX</b>	<b>0.88 M</b>	<b>1.01 M</b>
5.00M	<b>730 LUX</b>	<b>1.32 M</b>	<b>1.51 M</b>
6.67M	<b>411 LUX</b>	<b>1.76 M</b>	<b>2.01 M</b>
8.33M	<b>263 LUX</b>	<b>2.20 M</b>	<b>2.51 M</b>
10.00M	<b>182 LUX</b>	<b>2.64 M</b>	<b>3.01 M</b>

■ Vert. Spread: 15.0°  
■ Horiz. Spread: 17.1°

## LED Disclaimer

### LED Life

ILUMINARC® rates LED lifetime based on lumen depreciation of 70% of the original output, with data provided by the manufacturer of the LED. Data from the manufacturer of the LED are not independently verified or measured by ILUMINARC®. When the product is operating in optimal environmental conditions, the LED lifetime is rated to be 50,000 to 70,000 hours by the LED manufacturer.

### LED Binning

LED manufacturers sort LEDs into “bins,” based on variances in color, output intensity, and the frequency at which the semiconductor operates. ILUMINARC® strives to hold its LED manufacturers to the highest standards of binning to optimize consistency in output from product to product. However, the availability of a single bin cannot be guaranteed. With that in mind, ILUMINARC® has developed a rigorous control system to seek the best-achievable consistency in color and output.

### Color Rendering Index (CRI)

CRI is an industry standard method to compare properties of different types of light sources. There are known limitations and inconsistencies related to CRI. Results may vary depending on the environmental factors involved. For this reason, the U.S. Department of Energy (DOE) states that CRI should be considered as one point of reference among others in evaluating white LED products and systems.

The following is an excerpt of recommendations from the DOE:

1. Identify the visual tasks to be performed under the light source. If color fidelity under different light sources is critically important (for example, in a space where color or fabric comparisons are made under both daylight and electric lighting), CRI values may be a useful metric for rating LED products.
2. CRI may be compared only for light sources of equal correlated color temperature. This applies to all light sources, not only to LEDs. Also, differences in CRI values of less than five points are not significant, e.g., light sources with 80 and 84 CRI are essentially the same.
3. If color appearance is more important than color fidelity, do not exclude white light LEDs solely on the basis of relatively low CRI values. Some LED products with CRIs as low as 25 still produce visually pleasing white light.
4. Evaluate LED systems in person and, if possible, on-site when color fidelity or color appearance are important issues.

Source: DOE publication: PNNL-SA-56891, January 2008.

## Return Procedure



ILUMINARC® reserves the right to use its own discretion to repair or replace returned product(s).

You must send the merchandise prepaid, in the original box, and with its original packing and accessories. ILUMINARC® will not issue call tags.

Call ILUMINARC® and request a Return Merchandise Authorization Number (RMA #) before shipping the product. Be prepared to provide the model number, serial number, and a brief description of the cause for the return.

The user must clearly label the package with an RMA #. ILUMINARC® will refuse any product returned without an RMA #. **DO NOT write the RMA # directly on the box. Instead, write it on a properly affixed label.**

**Once you receive the RMA #, please include the following information on a piece of paper inside the box:**

- Your name
- Your address
- Your phone number
- The RMA #
- A brief description of the problem

Be sure to pack the product properly. Any shipping damage resulting from inadequate packaging will be the customer's responsibility. Proper FedEx packing or double-boxing are recommended.



Always keep the original box and all packaging material as you will need those to ship the product back to ILUMINARC®.

## Contact Us

### WORLD HEADQUARTERS - ILUMINARC®

#### General Information

Address: 5200 NW 108th Avenue  
Sunrise, FL 33351  
Voice: (954) 923-3680  
Fax: (800) 544-4898

#### Technical Support

Voice: (800) 762-1074  
Email: [support@iluminarc.com](mailto:support@iluminarc.com)

World Wide Web [www.iluminarc.com](http://www.iluminarc.com)

### UNITED KINGDOM AND IRELAND - Chauvet Europe Ltd.

#### General Information

Address: Unit 1C  
Brookhill Road Industrial Estate  
Pinxton, Nottingham, UK  
NG16 6NT  
Voice: +44 (0)1773 511115  
Fax: +44 (0)1773 511110

#### Technical Support

Email: [uktech@iluminarc.com](mailto:uktech@iluminarc.com)

World Wide Web [www.chauvetlighting.co.uk](http://www.chauvetlighting.co.uk)

### MEXICO - Chauvet Mexico

#### General Information

Address: Av. Santa Ana 30  
Parque Industrial Lerma  
Lerma, Mexico C.P. 52000  
Voice: +52 (728) 285-5000

#### Technical Support

Email: [servicio@iluminarc.com.mx](mailto:servicio@iluminarc.com.mx)

World Wide Web [www.chauvet.com.mx](http://www.chauvet.com.mx)

### CHAUVET EUROPE - Chauvet Europe BVBA

#### General Information

Address: Stokstraat 18  
9770 Kruishoutem  
Belgium  
Voice: +32 9 388 93 97

#### Technical Support

Email: [Eutech@chauvetlighting.eu](mailto:Eutech@chauvetlighting.eu)

World Wide Web [www.chauvetlighting.eu](http://www.chauvetlighting.eu)

Outside the U.S., United Kingdom, Ireland, Mexico, or Benelux, contact the dealer of record. Follow their instructions to request support or to return a product. Visit our website for contact details.



## 6. Technical Specifications

<b>Dimensions and Weight</b>	<b>Length</b>	<b>Width</b>	<b>Height</b>	<b>Weight</b>
	9.1 in (230 mm)	23.3 in (593 mm)	13.3 in (338 mm)	36.6 lb (16.6 kg)
<b>Note:</b> Dimensions and Weight are rounded to the nearest decimal digit.				
<b>Electrical</b>	<b>Power Supply Type</b>	<b>Range</b>	<b>Voltage Selection</b>	
	Switching (internal)	100–240 VAC, 50/60 Hz	Auto-ranging	
	<b>Parameter</b>	<b>120 V, 60 Hz</b>	<b>230 V, 50 Hz</b>	
	Consumption	251 W (2.1 A)	238 W (1.1 A)	
	<b>Power I/O</b>	<b>Input</b>	<b>Output</b>	
	Connectors	IP65 Input power	IP65 Output power	
	Cord plug	Edison	N/A	
<b>Light Source</b>	<b>Type</b>	<b>Power</b>	<b>Lifespan</b>	
	LED	15 W	50,000 hours	
	<b>Color</b>	<b>Quantity</b>	<b>Current</b>	
	Quad-color RGBA	36	985 mA	
<b>Photometrics</b>	<b>Parameter</b>	<b>Standard Optics</b>		
	Lumens	5,206		
	Efficacy	22.2 lm/W		
	Illuminance @ 5 m	5,070 lux		
	Beam angle	16°		
	Field angle	27°		
<b>Thermal</b>	<b>Max. External Temperature</b>	<b>Cooling System</b>		
	110 °F (43 °C)	Convection		
<b>DMX</b>	<b>I/O Connectors</b>	<b>Connector Type</b>	<b>Channel Range</b>	
	Proprietary IP65 3-pin	Sockets	4, 6 or 10	
<b>Ordering</b>	<b>Product Name</b>	<b>Item Code</b>	<b>UPC Code</b>	
	Colorist™ Panel 36Qa	03620840	781462211882	



UL 1573  
 CSA C22.2 No. 166  
 E113093



