

260 W Efficient, Compact Constant Voltage LED Drivers

Nominal Input Voltage	Max. Output Power	Nominal Output Voltage	Max. Output Current	Efficiency	Max. Case Temperature	THD	Power Factor
120 & 277 Vac 220 to 240 Vac	260 W	12, 24, 48 Vdc	21.6, 10.8, 5.4 A	up to 93% typical	90°C (measured at the hot spot)	< 20%	> 0.9

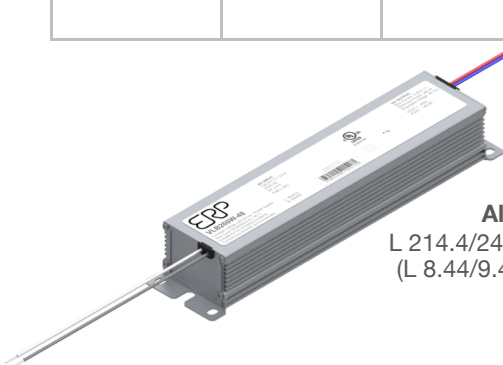

Aluminum Case:
L 214.4/240 x W 50.8 x H 38.5 mm
(L 8.44/9.47 x W 2.00 x H 1.52 in)



Typical Application Diagram

ORDERING INFORMATION

ERP Part Number	Nominal Input Voltage (Vac)	Pout Max (W)	Vout Nom (Vdc)	Iout Max (A)	Iout Min (A)	No Load Vout Max
VLB260W-12	120 & 277 Vac	260	12	21.67	1.08	12.84
VLB260W-24	120 & 277 Vac	260	24	10.83	0.54	25.68
VLB260W-48	120 & 277 Vac	260	48	5.42	0.27	51.36
VLB260E-48	220 to 240 Vac	260	48	5.42	0.27	51.36

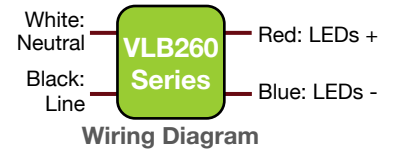

Wiring Diagram

FEATURES

- Very high power density of 10.2 W/in³
- IP66-rated case with silicone-based potting
- 90° C maximum case hot spot temperature
- Complies with ENERGY STAR® luminaire specification and DLC (Design Light Consortium®) technical requirements
- UL Class P
- Worldwide safety approvals

TYPICAL APPLICATIONS

- Horticulture
- Industrial lighting
- Outdoor and indoor



260 W Efficient, Compact Constant Voltage LED Drivers

1 - INPUT SPECIFICATION (@25° C ambient temperature)

	Units	Minimum	Typical	Maximum	Notes
Input Voltage Range (Vin)	Vac	90	120, 277	305	•The rated output voltage for each model is achieved at $V_{in} \geq 108$ Vac & at $V_{in} \geq 249$ Vac •At maximum load
-VLB260E-48		198	230	264	
Input Frequency Range	Hz	47	60	63	
-VLB260E-48		47	50	53	
Input Current	A			2.8 A @ 120 Vac 1.2 A @ 277 Vac 1.1 A @ 230 Vac	
Power Factor (PF)		0.9	> 0.9		•At nominal input voltage •From 100% to 50% of rated power
Inrush Current	A	Meets NEMA-410 requirements			•At any point on the sine wave and 25°C
Leakage Current	mA			0.5 mA @ 120 Vac 1.2 mA @ 277 Vac XX mA @ 230 Vac	
Input Harmonics	Complies with IEC61000-3-2 for Class C equipment				
Total Harmonics Distortion (THD)				20%	•At nominal input voltage and maximum load •Complies with DLC (Design Light Consortium) technical requirements
Efficiency	%	-	up to 93%	-	•At nominal input voltage and maximum load
Isolation	The AC input to main output is Class I (with earth ground)				

2 - MAIN OUTPUT SPECIFICATION (@25° C ambient temperature)

	Units	Minimum	Typical	Maximum	Notes
Output Voltage (Vout)	Vdc		12, 24, 48		See ordering information for details
Output Current (Iout)	A			12 Vdc: 21.67 A 24 Vdc: 10.83 A 48 Vdc: 5.42 A	•The rated output voltage for each model is achieved at $V_{in} \geq 108$ Vac & at $V_{in} \geq 249$ Vac.
Output Voltage Regulation	%	-5	± 2.5	5	•At nominal AC line voltage •Includes load and current set point variations
Output Voltage Overshoot	%	-	-	10	The driver does not operate outside of the regulation requirements for more than 500 ms during power on with maximum load.
Ripple Voltage	$\leq 5\%$ of rated output voltage for each model				•Measured at maximum load and nominal input voltage •Calculated in accordance with the IES Lighting Handbook, 9th edition
Start-up Time	ms			750	•Measured from application of AC line voltage to 100% light output •Complies with ENERGY STAR® luminaire specification
Isolation	The AC input to main output is Class I (with earth ground)				



VLB260 Series

260 W

260 W Efficient, Compact Constant Voltage LED Drivers

3 - ENVIRONMENTAL CONDITIONS

	Units	Minimum	Typical	Maximum	Notes
Operating Ambient Temperature (Ta)	°C	-40		50	50°C is the non-derated temperature
Maximum Case Temperature (Tc)	°C			+90	Case temperature measured at the hot spot •tc (see label in page 11)
Storage Temperature	°C	-40		+85	
Humidity	%	5	-	95	Non-condensing
Cooling	Convection cooled				
Acoustic Noise	dBA			22	Measured at a distance of 1 foot (30 cm)
Mechanical Shock Protection	per EN60068-2-27				
Vibration Protection	per EN60068-2-6 & EN60068-2-64				
MTBF	> 200,000 hours when operated at nominal input and output conditions, and at Tc ≤ 70°C				
Lifetime	50,000 hours at Tc ≤ 70°C maximum case hot spot temperature (see hot spot •tc on label in page 11)				

4 - EMC COMPLIANCE AND SAFETY APPROVALS

EMC Compliance					
Conducted and Radiated EMI	FCC CFR Title 47 Part 15 Class A at 120 Vac and at 277 Vac				
Harmonic Current Emissions	IEC61000-3-2 For Class C equipment				
Voltage Fluctuations & Flicker	IEC61000-3-3				
Immunity Compliance	ESD (Electrostatic Discharge) IEC61000-4-2 6 kV contact discharge, 8 kV air discharge, level 3				
	RF Electromagnetic Field Susceptibility IEC61000-4-3 3 V/m, 80 - 1000 MHz, 80% modulated at a distance of 3 meters				
	Electrical Fast Transient IEC61000-4-4 ± 2 kV on AC power port for 1 minute, ±1 kV on signal/control lines				
	Surge IEC61000-4-5 • ± 4 kV line to line (differential mode) / ± 4 kV line to common mode ground (tested to secondary ground) on AC power port, ±0.5 kV for outdoor cables • Higher surge is available. Please contact your ERP representative or send an email to SaveEnergy@erp-power.com. ANSI/IEEE c62.41.1-2002 & c62.41.2-2002 category A, 2.5 kV ring wave				
	Conducted RF Disturbances IEC61000-4-6 3V, 0.15-80 MHz, 80% modulated				
	Voltage Dips IEC61000-4-11 >95% dip, 0.5 period; 30% dip, 25 periods; 95% reduction, 250 periods				
Safety Agency Approvals					
UL	UL8750 recognized, Class P				
cUL	CAN/CSA C22.2 No. 250.13-14 LED equipment for lighting applications				
Safety					
	Units	Minimum	Typical	Maximum	Notes
Hi Pot (High Potential) or Dielectric voltage-withstand	Vdc	2500			• Insulation between the input (AC line and Neutral) and the output • Tested at the RMS voltage equivalent of 1767 Vac



VLB260 Series

260 W

260 W Efficient, Compact Constant Voltage LED Drivers

■ 5 - PROTECTION FEATURES

Under-Voltage (Brownout)

The VLB260 series provides protection circuitry such that an application of an input voltage below the minimum stated in section 1 (Input Specification) shall not cause damage to the driver.

Short Circuit and Over Current Protection

The VLB260 series is protected against short-circuit such that a short from any output to return shall not result in a fire hazard or shock hazard. The driver shall hiccup as a result of a short circuit or over current fault. Removal of the fault will return the driver to within normal operation. The driver shall recover, with no damage, from a short across the output for an indefinite period of time.

Internal Over temperature Protection

The VLB260 series incorporates circuitry that prevents internal damage due to an over temperature condition. An over temperature condition may be a result of an excessive ambient temperature or as a result of an internal failure. When the over temperature condition is removed, the driver shall automatically recover.

Output Open Load

The VLB260 is equipped with internal temperature sensor on the primary power train. Failure to stay within the convection power rating will result in the power supply reducing the available output current (fold back). The main output current will be resumed when the temperature of the built-in temperature sensor cools adequately.

Over Power Protection

The driver will shut down and auto recover when its input power exceeds approximately 110% of 260W. This condition will cause no damage to the power supply.

260 W Efficient, Compact Constant Voltage LED Drivers

7 - PREDICTED LIFETIME VERSUS CASE AND AMBIENT TEMPERATURE

Lifetime is defined by the measurement of the temperatures of all the electrolytic capacitors whose failure would affect light output under the nominal LED load and worst case AC line voltage. The graphs here below are determined by the electrolytic capacitor with the shortest lifetime, among all electrolytic capacitors. It represents a worst case scenario in which the LED driver is powered 24 hours/day, 7 days/week. The lifetime of an electrolytic capacitor is measured when any of the following changes in performance are observed:

- 1) Capacitance changes more than 20% of initial value
- 2) Dissipation Factor ($\tan \delta$): 150% or less of initial specified value
- 3) Equivalent Series Resistance (ESR): 150% or less of initial specified value
- 4) Leakage current: less of initial specified value

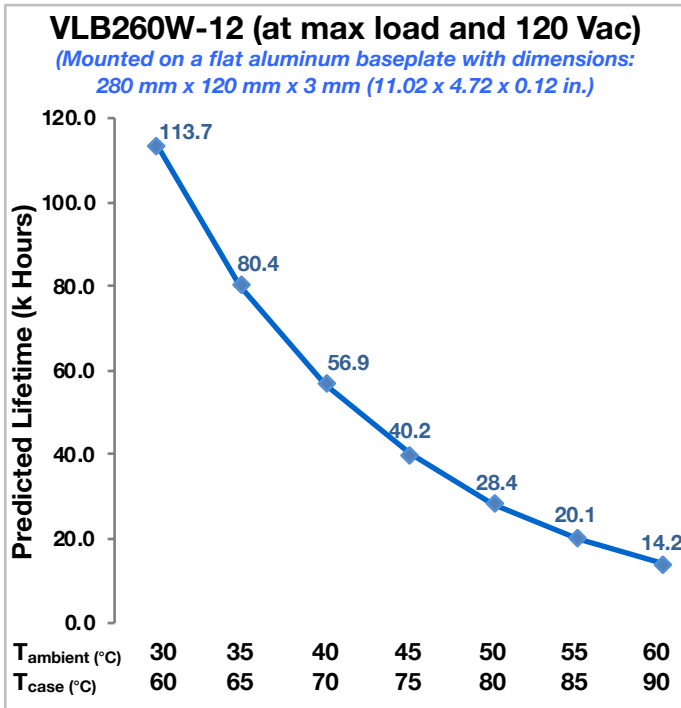

Figure 1

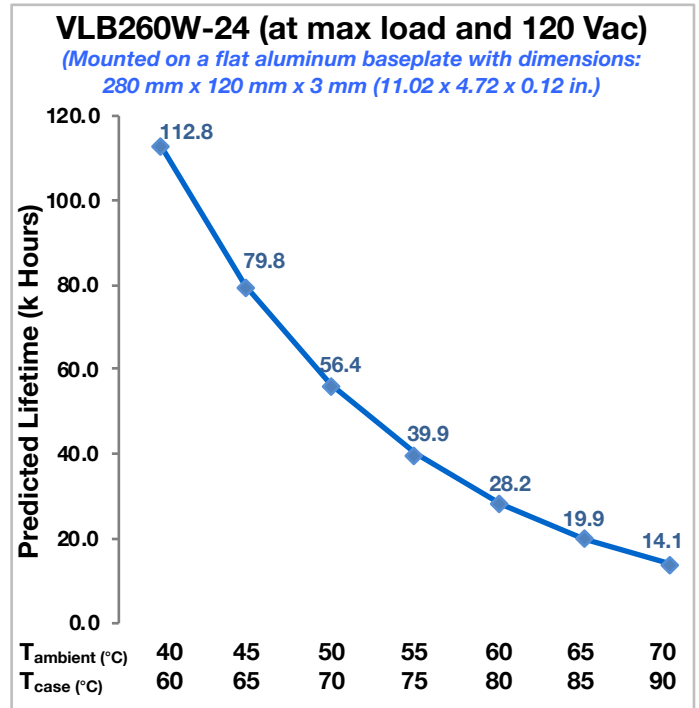

Figure 2

Notes:

- The ambient temperature T_{ambient} and the differential between T_{ambient} and T_{case} mentioned in the above graphs are relevant only as long as both the driver and the light fixture are exposed to the same ambient room temperature. If the LED driver is housed in an enclosure or covered by insulation material, then the ambient room temperature is no longer valid. In this situation, please refer only to the case temperature T_{case} .
- It should be noted the graph "Lifetime vs. Ambient Temperature" may have an error induced in the final application if the mounting has restricted convection flow around the case. For applications where this is evident, the actual case temperature measured at the T_c point in the application should be used for reliability calculations.

260 W Efficient, Compact Constant Voltage LED Drivers

7 - PREDICTED LIFETIME VERSUS CASE AND AMBIENT TEMPERATURE (CONTINUED)

Lifetime is defined by the measurement of the temperatures of all the electrolytic capacitors whose failure would affect light output under the nominal LED load and worst case AC line voltage. The graph here below are determined by the electrolytic capacitor with the shortest lifetime, among all electrolytic capacitors. It represents a worst case scenario in which the LED driver is powered 24 hours/day, 7 days/week. The lifetime of an electrolytic capacitor is measured when any of the following changes in performance are observed:

- 1) Capacitance changes more than 20% of initial value
- 2) Dissipation Factor ($\tan \delta$): 150% or less of initial specified value
- 3) Equivalent Series Resistance (ESR): 150% or less of initial specified value
- 4) Leakage current: less of initial specified value

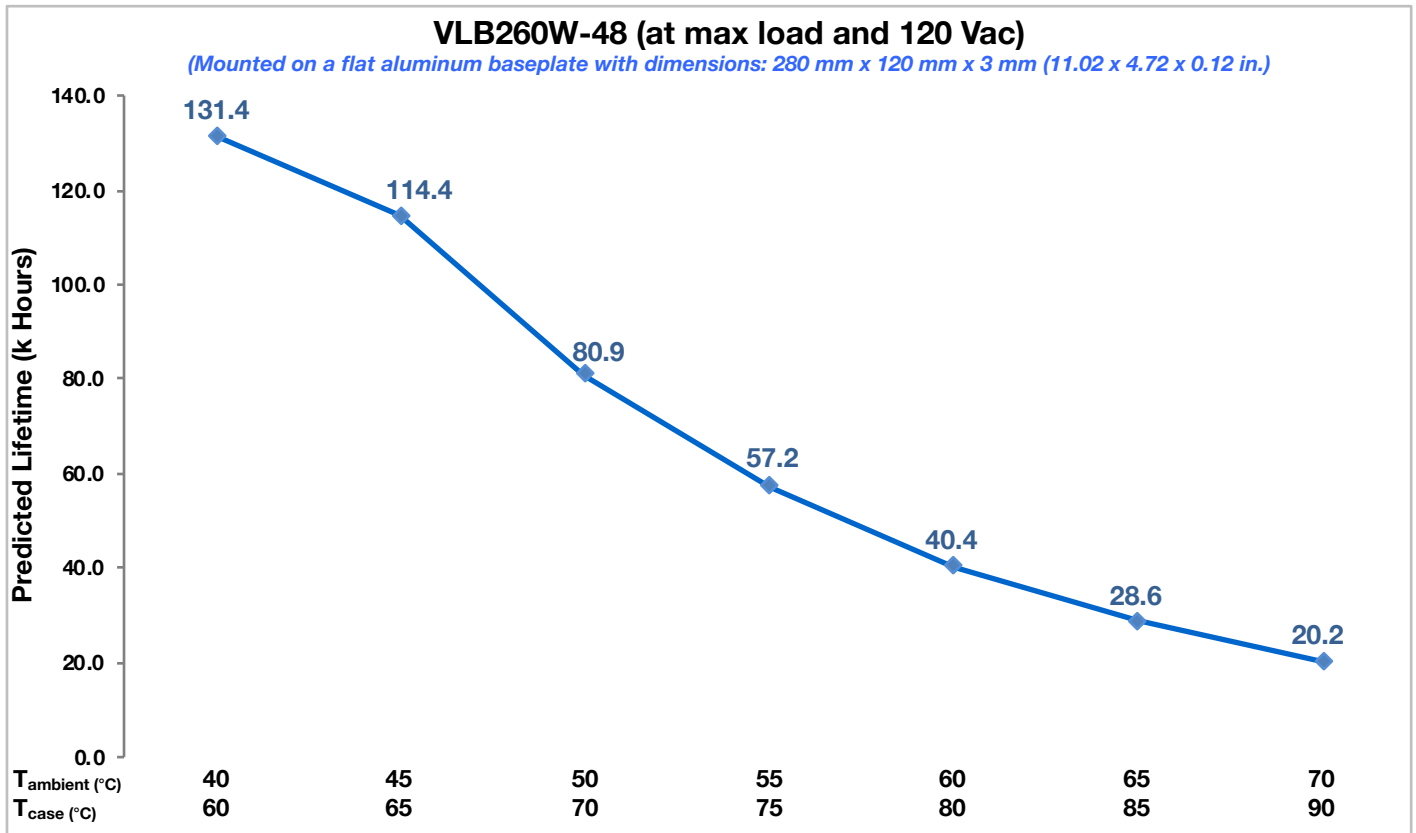

Figure 3

Notes:

- The ambient temperature T_{ambient} and the differential between T_{ambient} and T_{case} mentioned in the above graphs are relevant only as long as both the driver and the light fixture are exposed to the same ambient room temperature. If the LED driver is housed in an enclosure or covered by insulation material, then the ambient room temperature is no longer valid. In this situation, please refer only to the case temperature T_{case} .
- It should be noted the graph “Lifetime vs. Ambient Temperature” may have an error induced in the final application if the mounting has restricted convection flow around the case. For applications where this is evident, the actual case temperature measured at the T_c point in the application should be used for reliability calculations.

260 W Efficient, Compact Constant Voltage LED Drivers

8 – EFFICIENCY VERSUS LOAD

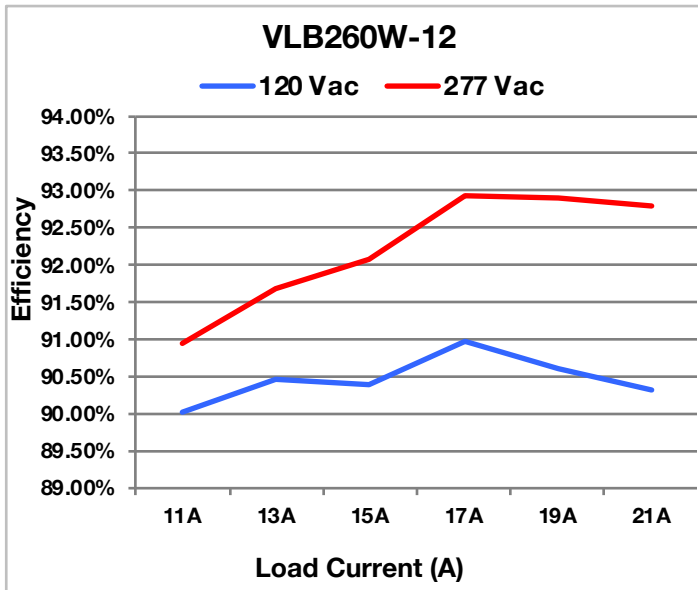

Figure 4

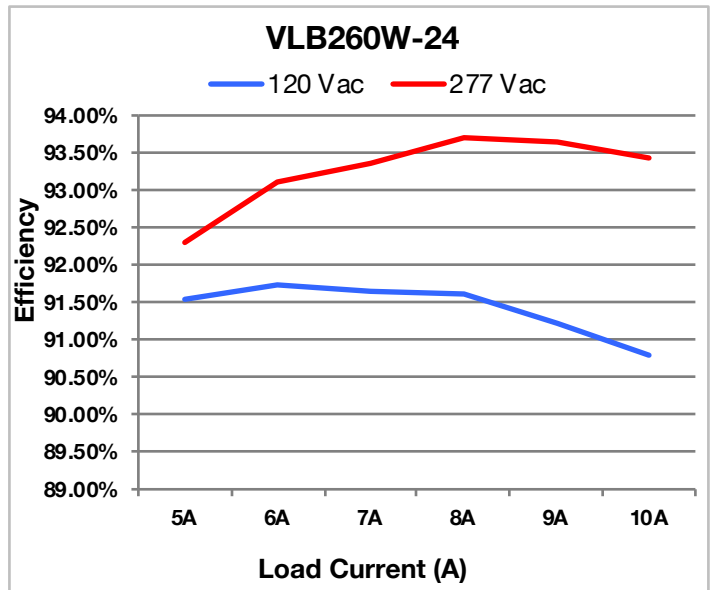

Figure 5

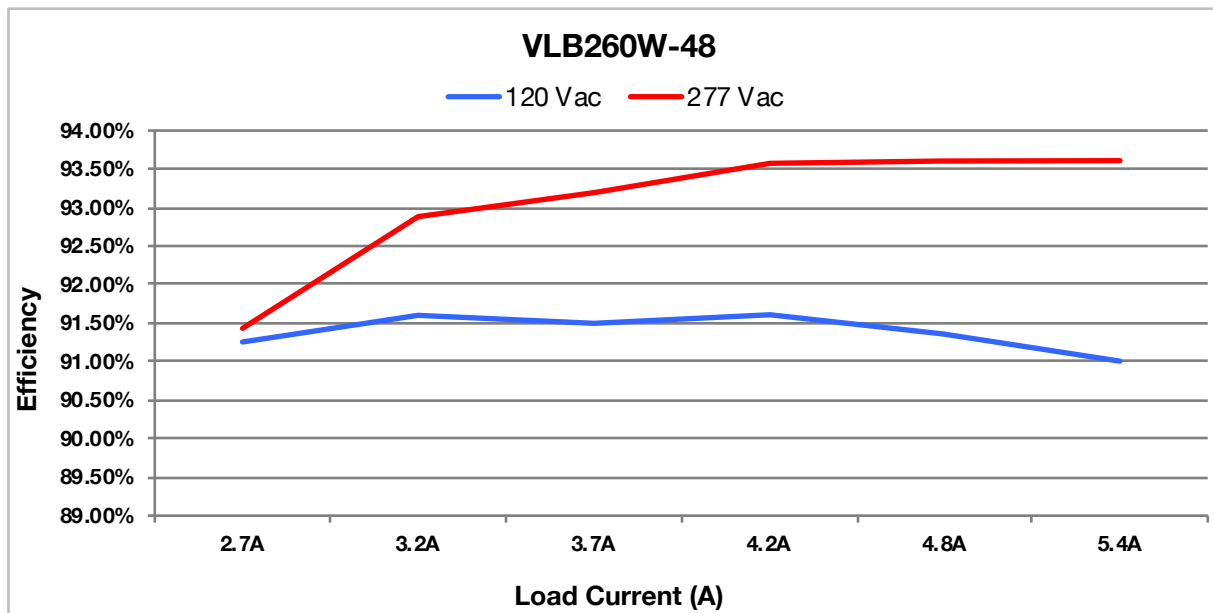

Figure 6

260 W Efficient, Compact Constant Voltage LED Drivers

9 – POWER FACTOR VERSUS LOAD

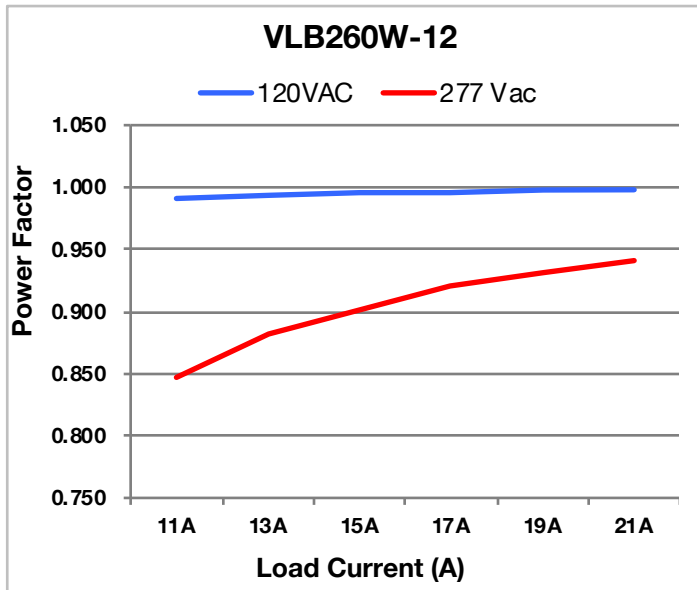

Figure 7

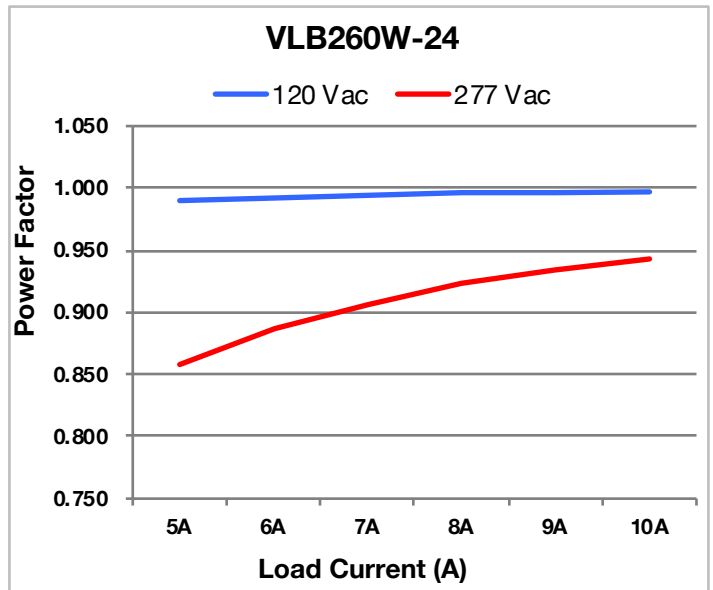

Figure 8

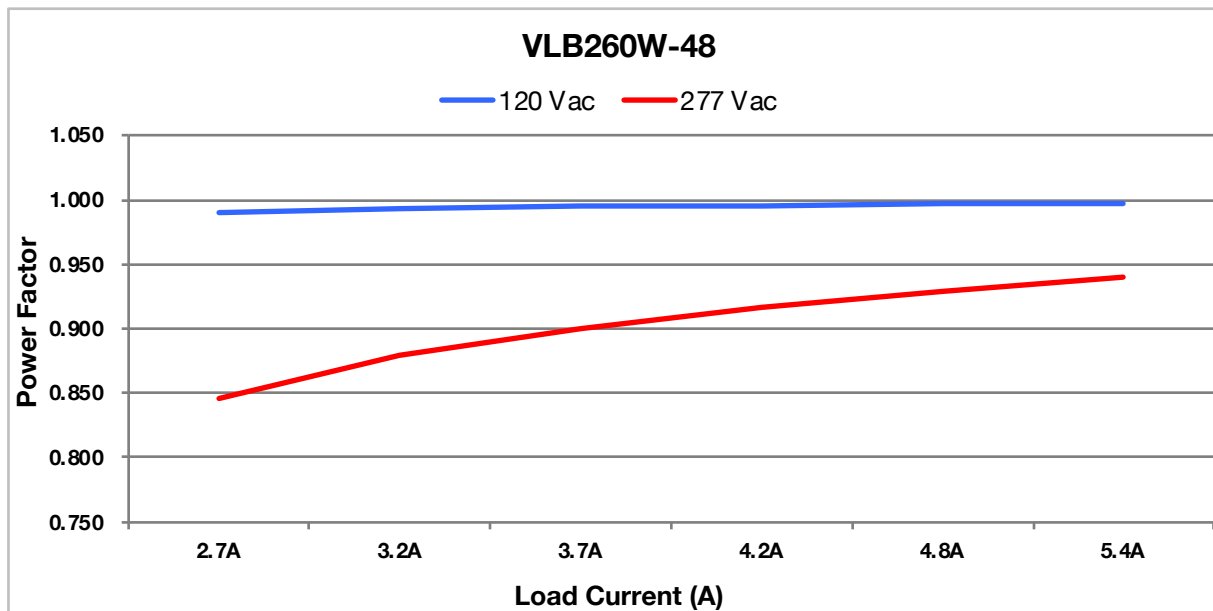

Figure 9

260 W Efficient, Compact Constant Voltage LED Drivers

10 – THD VERSUS LOAD

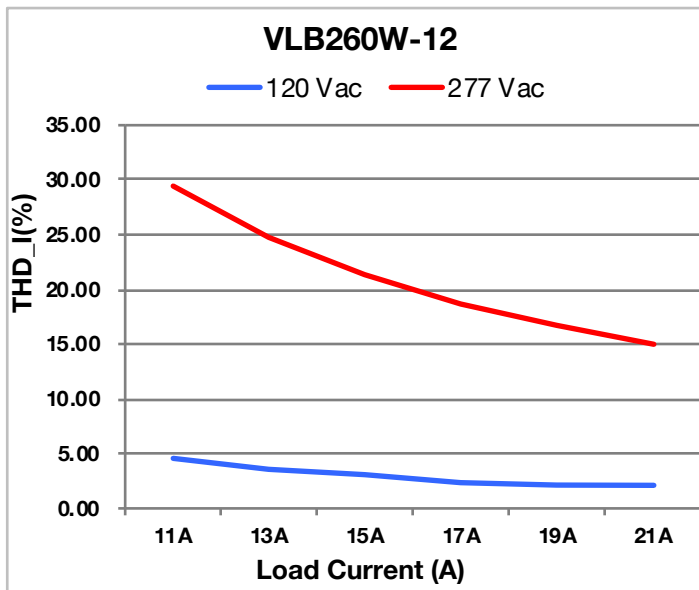

Figure 10

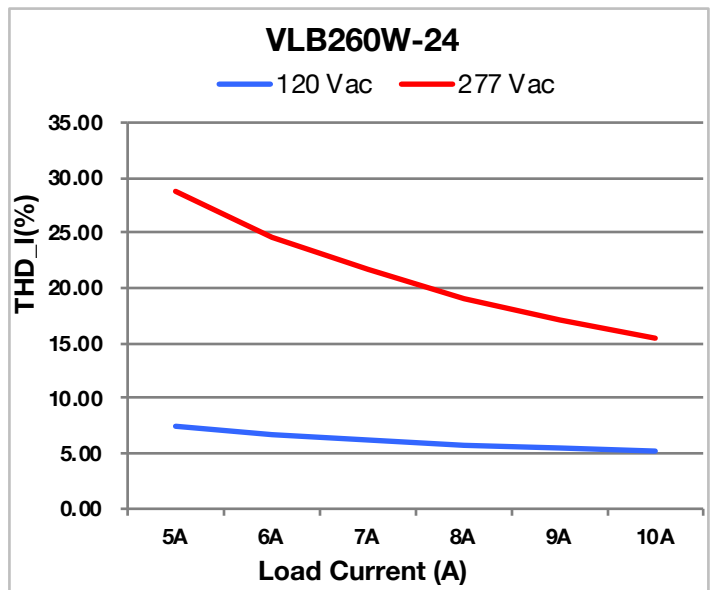

Figure 11

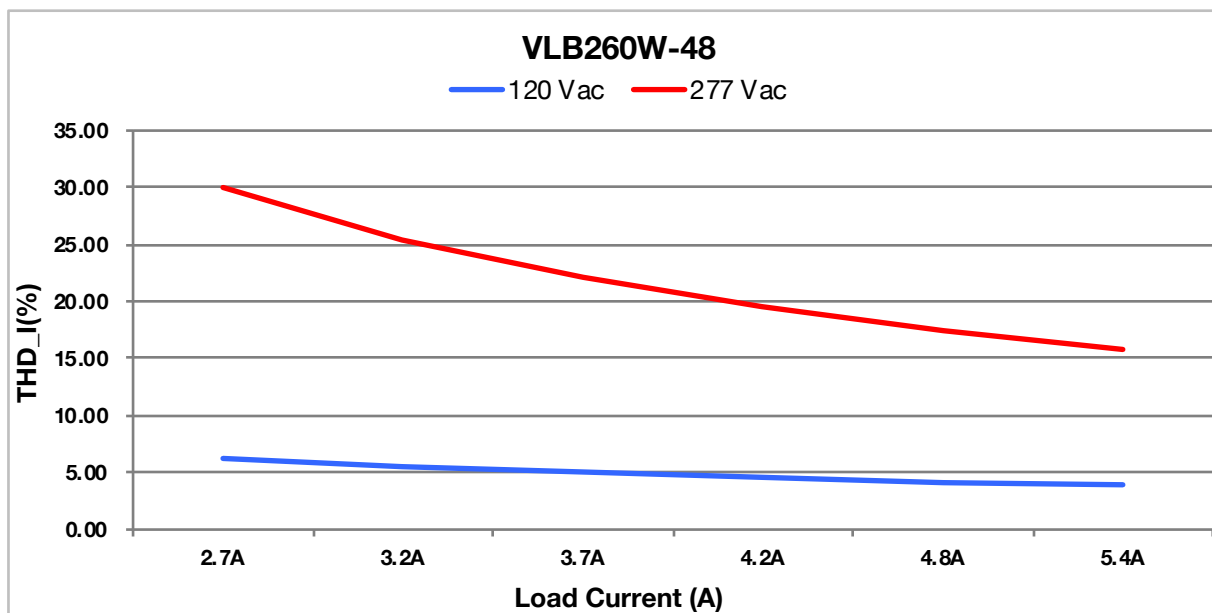

Figure 12

260 W Efficient, Compact Constant Voltage LED Drivers

11 - MECHANICAL DETAILS

- Packaging Options:** Aluminum case
- I/O Connections:** Flying leads, 18 AWG on AC input leads and 16 AWG on DC output leads, 203mm (8 in) long, 105°C rated, stranded, stripped by approximately 9.5mm, and tinned. All the wires, on both input and output, have a 600 V insulation rating.
- Ingress Protection:** IP66 rated
- Mounting Instructions:** The VLB260 driver case must be secured on a flat surface through the two mounting tabs, shown here below in the case outline drawings. We recommended mounting the VLB260 driver case on a flat aluminum baseplate with dimensions: 280 mm x 120 mm x 3 mm (11.02 x 4.72 x 0.12 in.).

12 - OUTLINE DRAWINGS

- Dimensions:** L 214.4/240 x W 50.8 x H 38.6 mm (L 8.44/9.47 x W 2.00 x H 1.52 in)
- Volume:** 420.4 cm³ (25.65 in³)
- Weight:**

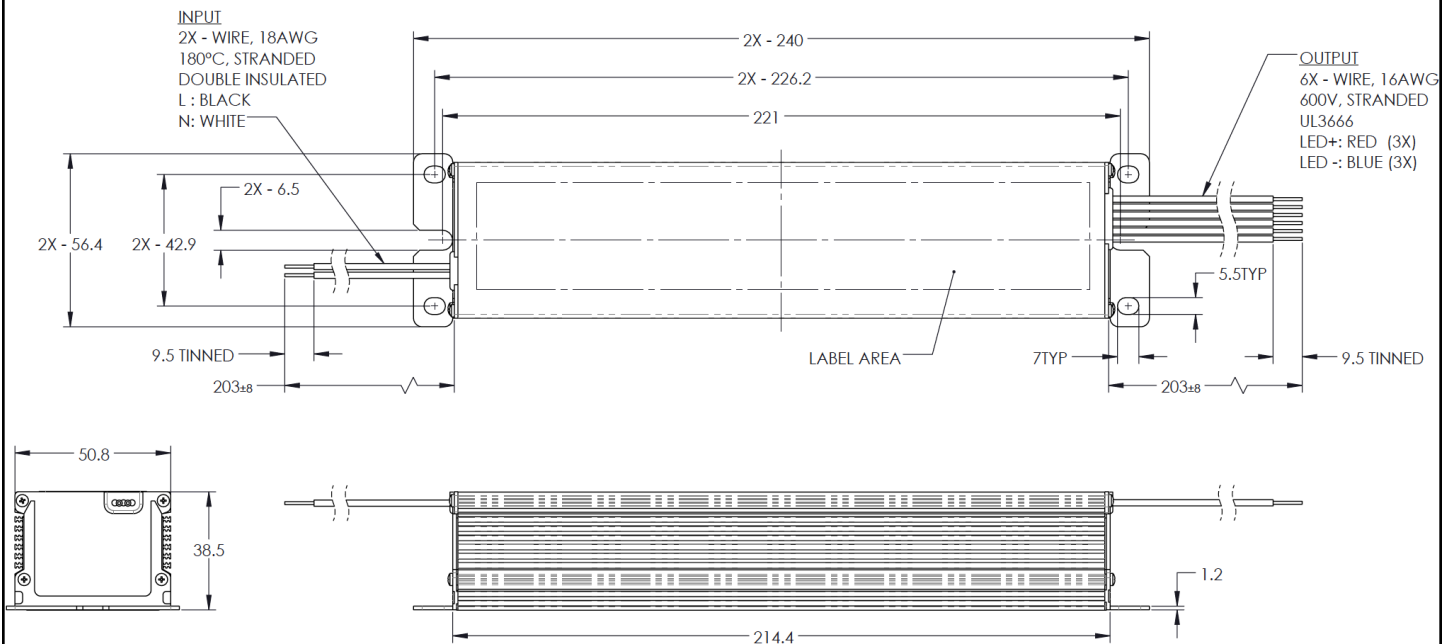

All dimensions are in mm

Figure 13



VLB260 Series

260 W

260 W Efficient, Compact Constant Voltage LED Drivers

13 - LABELING

The VLB260W-24 is used in figure 14 as an example to illustrate a typical label.

	AC INPUT: 120/277 V ~ 2.8 A 50/60 Hz PF ≥ 0.9 THD ≤ 20%			DC OUTPUT: Max Current 10.83 A Maximum Power 260 W Regulated Voltage 24 Vdc VOUT + : RED VOUT - : BLUE
VLB260W-24 Constant Voltage LED Driver / Power Supply Max Case Temperature $t_c = 90^\circ\text{C}$ Suitable for Dry or Damp Locations <i>Convient aux endroits secs et humides</i>	L : BLACK N : WHITE	Designed in the USA Manufactured in China (serial label)		 IMPORTANT! <i>Bond all conductors in the same polarity before power connection</i>

Figure 14

ERP Power, LLC (ERP) reserves the right to make changes without further notice to any products herein. ERP makes no warranty, representation or guarantee regarding the suitability of its products for any particular purpose, nor does ERP assume any liability arising out of the application or use of any product or circuit, and specifically disclaims any and all liability, including without limitation special, consequential or incidental damages. "Typical" parameters which may be provided in ERP data sheets and/or specifications can and do vary in different applications and actual performance may vary over time. All operating parameters, including "Typicals" must be validated for each customer application by customer's technical experts. ERP does not convey any license under its patent rights nor the rights of others. ERP products are not designed, intended, or authorized for use as components in systems intended for surgical implant into the body, or other applications intended to support or sustain life, or for any other application in which the failure of the ERP product could create a situation where personal injury or death may occur. Should Buyer purchase or use ERP products for any such unintended or unauthorized application, Buyer shall indemnify and hold ERP and its officers, employees, subsidiaries, affiliates, and distributors harmless against all claims, costs, damages, and expenses, and reasonable attorney fees arising out of, directly or indirectly, any claim of personal injury or death associated with such unintended or unauthorized use, even if such claim alleges that ERP was negligent regarding the design or manufacture of the part. ERP is an Equal Opportunity/Affirmative Action Employer. This literature is subject to all applicable copyright laws and is not for resale in any manner.