

SYSTEM DESCRIPTION

The Environmental Lights 3-in Remote Voltage Illumination (REVI) downlight system is a low-voltage, Class-2 constant current solution designed to give integrators ultimate control and flexibility over their lighting installations. The 3-inch REVI downlight system allows lighting designers and integrators to select their brightness level, optic, media insert, baffle, trim and mounting frame for a comprehensive downlighting solution.

Ideal Application: Residential and Architectural downlighting up to 700 lumens for human centric, circadian-based lighting system.

Parts A-F make up the Remove Voltage Illumination (REVI) Downlight System.

A LIGHT ENGINES



REVI LE1 Light Engine 18 Volts [9 W, 18 V, 500 mA]
(2700K - 6500K)
REVI-LE1-18V-2765K

B OPTICS



REVI LE1 13° Narrow Lens*
REVI-LE1-L-13D
**Can be paired with REVI LE1 60° Flood Insert to create a 60° beam angle.*

REVI LE1 18° Medium Lens
REVI-LE1-L-18D

REVI LE1 31° Wide Lens
REVI-LE1-L-31D

C MEDIA INSERTS [optional]



REVI LE1 60° Flood Insert
REVI-LE1-IN-FL
**In order to function as intended, this insert pairs with REVI LE1 13° Narrow Lens to create a 60° beam angle.*



REVI LE1 Clear Glass Insert
REVI-LE1-IN-CG



REVI LE1 Acrylic Diffuser Insert
REVI-LE1-IN-AD



REVI LE1 Prismatic Glass Insert
REVI-LE1-IN-PG



REVI LE1 Honeycomb Insert
REVI-LE1-IN-HC



REVI LE1 Striped Glass Insert
REVI-LE1-IN-SG

D BAFFLES



REVI 3-inch LE1 Baffle, Round Fixed
REVI-LE1-B3-RF-W



REVI 3-inch LE1 Baffle, Round Adjustable
REVI-LE1-B3-RA-W



REVI 3-inch LE1 Baffle, Round Wall Wash
REVI-LE1-B3-RW-W

TECHNICAL SPECIFICATIONS

Tunable Channels	2700K	6500K
Brightness	620 lm	850 lm
Drive Current	500 mA	500 mA
Forward Voltage	18 Vdc	18 Vdc
Power Draw	9 Watts	9 Watts
CRI	90+	90+
Fixtures per Linkable Pair of Channels	2	2
	Up to 12 fixtures per 12-Channel Power Supply	

The sum of drive currents across both channels cannot exceed 500 mA

D BAFFLES [continued]

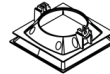

REVI 3-inch LE1 Baffle, Square Fixed
REVI-LE1-B3-SF-W



REVI 3-inch LE1 Baffle, Square Adjustable
REVI-LE1-B3-SA-W

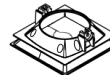

REVI 3-inch LE1 Baffle, Square Wall Wash
REVI-LE1-B3-SW-W

E TRIMS



REVI 3-inch LE1 Trim, Round
REVI-LE1-T3-R-W



REVI 3-inch LE1 Trimless Plate, Round
REVI-LE1-TL3-R



REVI 3-inch LE1 Trim, Square
REVI-LE1-T3-S-W

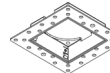

REVI 3-inch LE1 Trimless Plate, Square
REVI-LE1-TL3-S

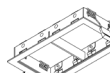

REVI 3-inch LE1 Trim, Double Square
REVI-LE1-T3-2S-W



REVI 3-inch LE1 Trim, Triple Square
REVI-LE1-T3-3S-W

F MOUNTING FRAMES

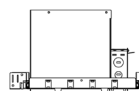

IC Rated Box, Round
REVI-IC3-R



IC Rated Box, Square
REVI-IC3-S1



Flat Mounting Frame, Round
REVI-FF3-R

Flat Mounting Frame, Square
REVI-FF3-S1

FIXTURE OPTIONS

- Light Engines** - Tunable White, 2700K - 6500K [620 lm - 850 lm]
- Optics** - Narrow [13°], Medium [18°], Wide [31°]
- Media Inserts** - 60° Flood, Acrylic Diffuser, Clear Glass, Striped Glass, Prismatic Glass, Honeycomb
- Baffles** - Round Fixed, Round Adjustable, Round Wall Wash, Square Fixed, Square Adjustable, Square Wall Wash
- Trims** - Single Round, Single Square, Single Trimless Round, Single Trimless Square, Double Square, Triple Square
- Mounting** - IC Rated Box Round, Flat Frame Round, IC Rated Box Square, Flat Frame Square

REGULATORY

- UL Listed
- Class-2
- Can be used to comply with CA Title-24 JA8
- RoHS
- IP44 Rated
- IC Rated (Fixed & Wall Wash only)*

*Always adhere to local installation standards and guidelines

The sum of drive currents across both channels cannot exceed 500 mA

ASSEMBLY BUILDER

Example: REVI-LE1-18V-2765K-13D-AD-RF-T3-R = 18 Volt, 9 Watt Light Engine, 2700K-6500K CCT, 13 Degree Lens, Acrylic Diffuser Media Insert, Round Fixed Baffle, Round Trim (all white). Note: To create a 60 degree beam of light, you must list 13 Degree Lens + the 60 degree Flood Insert (13D + FL) when using the assembly builder.

REVI-LE1	18V	2765K				
Fixture Series	Light Engine	Color Temperature	Lens	Media Insert	Baffle	Trim
			13D = 13 Degrees	FL = 60 Degree Flood Insert	RF = Round Fixed	T3-R = Round Trim
			18D = 18 Degrees	AD = Acrylic Diffuser	RA = Round Adjustable	TL3-R = Round Trimless
			31D = 31 Degrees	SG = Striped Glass	RW = Round Wall Wash	T3-S = Square Trim
			WW = Wall Wash Baffle Only	PG = Prismatic Glass	SF = Square Fixed	TL3-S = Square Trimless
				CG = Clear Glass	SA = Square Adjustable	T3-2S = Double Square Trim
				HC = Honeycomb	SW = Square Wall Wash	T3-3S = Triple Square Trim
				OP = Open [No Insert]		

SYSTEM CHARACTERISTICS

A LIGHT ENGINES



REVI LE1 Light Engine 18 V

9 Watts [2700K-6500K]

REVI-LE1-18V-2765K

Two-channel 18 Volt, 9 Watt compact light engine is designed and optimized for Tunable White lighting applications. It is ideal for Residential and Architectural downlighting up to 700 lumens for human centric, circadian-based lighting system.

B OPTICS



REVI LE1 13° Narrow Lens

REVI-LE1-L-13D

A narrow flood lens that delivers a precision-targeted beam of light. It can be paired with REVI LE1 60° to create a 60° beam angle.



REVI LE1 18° Medium Lens

REVI-LE1-L-18D

A spot lens that delivers a medium-sized beam of light that brings attention to areas that need to be highlighted.



REVI LE1 31° Wide Lens

REVI-LE1-L-31D

A flood lens that delivers a wide beam of light to provide full illumination for a space.

C MEDIA INSERTS [optional]



REVI LE1 60° Flood Insert

REVI-LE1-IN-FL

In order to function as intended, this insert pairs with REVI LE1 13° Narrow Lens to create a 60° beam angle.



REVI LE1 Striped Glass Insert

REVI-LE1-IN-SG

Designed to elongate the light pattern at the lens surface when a wider spread or wash is needed.



REVI LE1 Clear Glass Insert

REVI-LE1-IN-CG

Intended to provide a sheer surface without obstructing the light dispersion from the lens.



REVI LE1 Acrylic Diffuser Insert

REVI-LE1-IN-AD

Engineered to soften the light output at the lens for even distribution of light.



REVI LE1 Prismatic Glass Insert

REVI-LE1-IN-PG

Designed with a hatch pattern to spread the light at the lens for maximum dispersion.



REVI LE1 Honeycomb Insert

REVI-LE1-IN-HC

Engineered to minimize off-angle glare with the intent of eliminating any orb effect around the fixture.

D BAFFLES / **ROUND & SQUARE**



REVI 3-inch LE1 Baffle, Round Fixed
REVI-LE1-B3-RF-W

A fixed-position round trim option for your lighting fixture.

Color - White



REVI 3-inch LE1 Baffle, Round Adjustable
REVI-LE1-B3-RA-W

A round trim option that enables adjustment of the angle of light.

Color - White



REVI 3-inch LE1 Baffle, Round Wall Wash
REVI-LE1-B3-RW-W

A round fixed-position, preconfigured option that provides an even spread of light on a wall.

Color - White



REVI 3-inch LE1 Baffle, Square Fixed
REVI-LE1-B3-SF-W

A fixed-position square trim option for your lighting fixture.

Color - White

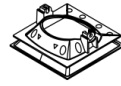

REVI 3-inch LE1 Baffle, Square Adjustable
REVI-LE1-B3-SA-W

A square trim option that enables adjustment of the angle of light.

Color - White



REVI 3-inch LE1 Baffle, Square Wall Wash
REVI-LE1-B3-SW-W

A square fixed-position, preconfigured option that provides an even spread of light on a wall.

Color - White

E TRIMS / **ROUND & SQUARE**



REVI 3-inch LE1 Trim, Round
REVI-LE1-T3-R-W

Round trim option that provides a sleek appearance for your downlighting fixture.

Color - White

CEILING CUT

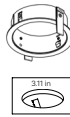

TRIM DIAMETER



Ø3.35 in [85 mm]

FIXED

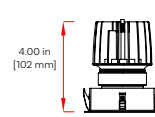

4.00 in [102 mm]

ADJUSTABLE

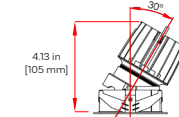

4.13 in [105 mm]

WALL WASH

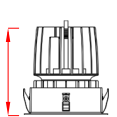

3.47 in [88 mm]



REVI 3-inch LE1 Trimless Plate, Round
REVI-LE1-TL3-R

A round trimless option that provides seamless blending between the fixture and the ceiling.

Color - White

CEILING CUT



TRIM DIAMETER

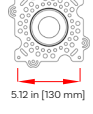

5.12 in [130 mm]

FIXED

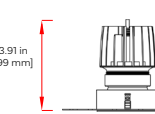

3.91 in [99 mm]

ADJUSTABLE

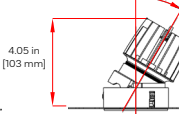

4.05 in [103 mm]

WALL WASH

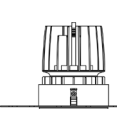

3.38 in [86 mm]

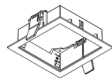

REVI 3-inch LE1 Trim, Square
REVI-LE1-T3-S-W

A square trim option that provides a sleek appearance for your downlighting fixture.

Color - White

CEILING CUT

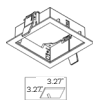

TRIM DIMENSIONS

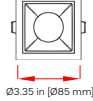

Ø3.35 in [85 mm]

FIXED

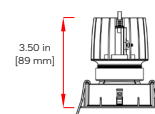

3.50 in [89 mm]

ADJUSTABLE

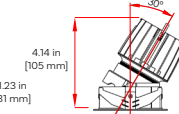

4.14 in [105 mm]

WALL WASH

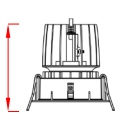

3.47 in [88 mm]

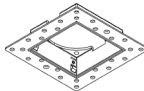

REVI 3-inch LE1 Trimless Plate, Square
REVI-LE1-TL3-S

A round trimless option that provides seamless blending between the fixture and the ceiling.

Color - White

CEILING CUT

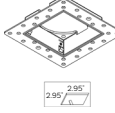

TRIM DIMENSIONS

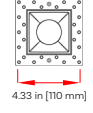

4.33 in [110 mm]

FIXED

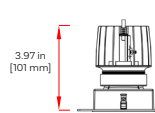

3.97 in [101 mm]

ADJUSTABLE

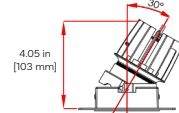

4.05 in [103 mm]

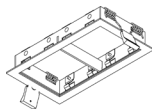

REVI 3-inch LE1 Trim, Double Square
REVI-LE1-T3-2S-W

A convenient multiple square trim option that provides a polished look for your downlighting fixture.

Color - White

CEILING CUT



TRIM DIMENSIONS



1.10 in [28 mm]

6.46 in [164 mm]

FIXED

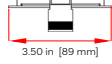

3.50 in [89 mm]

ADJUSTABLE



3.66 in [93 mm]

6.46 in [164 mm]

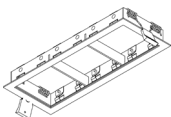

REVI 3-inch LE1 Trim, Triple Square
REVI-LE1-T3-3S-W

A convenient multiple square trim option that provides a polished look for your downlighting fixture.

Color - White

CEILING CUT



TRIM DIMENSIONS



1.10 in [28 mm]

9.25 in [235 mm]

FIXED



3.50 in [89 mm]

ADJUSTABLE



3.66 in [93 mm]

9.25 in [235 mm]

F MOUNTING FRAMES / ROUND & SQUARE

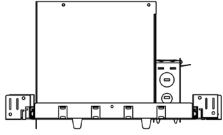

REVI 3-inch IC Rated Box, Round
REVI-IC3-R

Recess-mounted frame for safe and easy installation of your lighting fixture. Engineered to be compatible with round baffle and trim options.

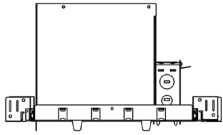
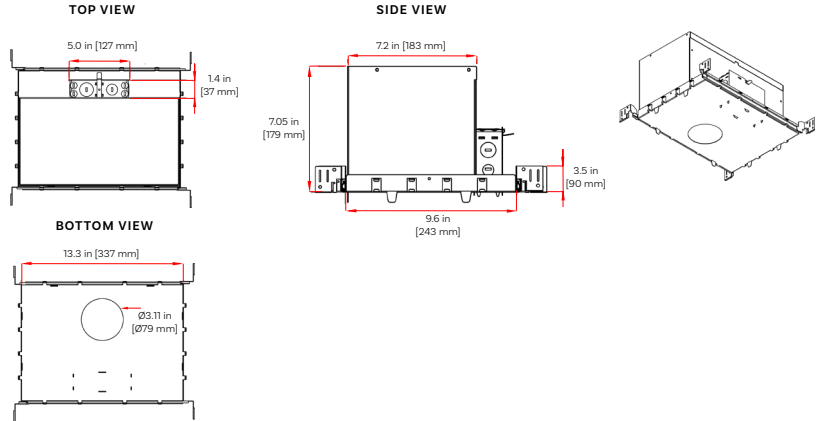

REVI 3-inch IC Rated Box, Square
REVI-IC3-S1

REVI 3-inch IC Rated Box, Square Double
REVI-IC3-S2

REVI 3-inch IC Rated Box, Square Triple
REVI-IC3-S3

Recess-mounted frame for safe and easy installation of your lighting fixture. Engineered to be compatible with square baffle and trim options.

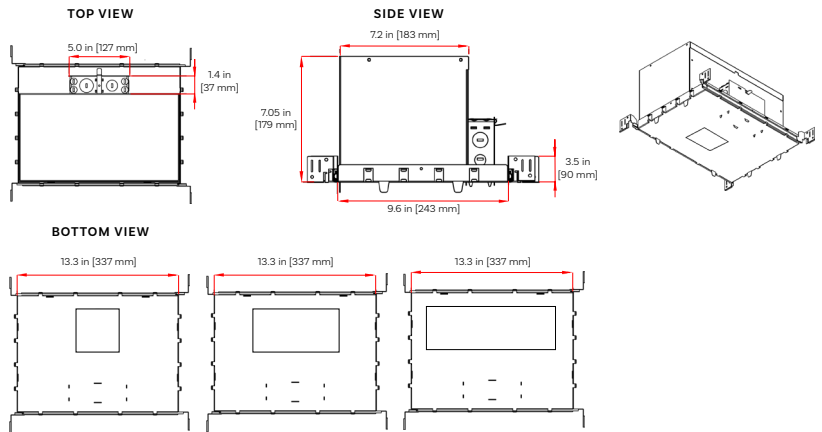

REVI 3-inch Flat Mounting Frame, Round
REVI-FF3-R

A thin mounting frame that allows your fixture to be built directly into the ceiling. Engineered to be compatible with round baffle and trim options.

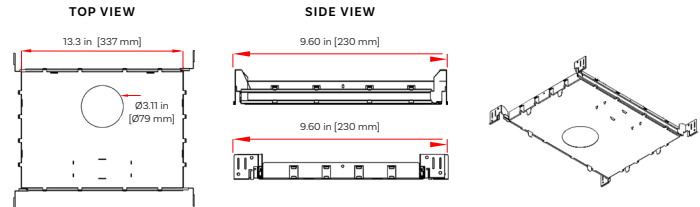

REVI 3-inch Flat Mounting Frame, Square
REVI-FF3-S1

REVI 3-inch IC Rated Box, Square Double
REVI-FF3-S2

REVI 3-inch IC Rated Box, Square Triple
REVI-FF3-S3

A thin mounting frame that allows your fixture to be built directly into the ceiling. Engineered to be compatible with square baffle and trim options.

