

Pixel EcoFlex 4-in-1 LED Neon - Vertical Bend

PLN-ECO-VB-RGBX-10m

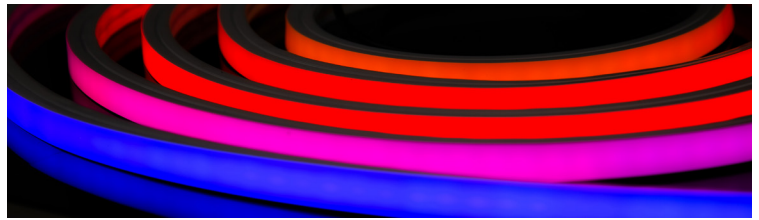

PRODUCT DESCRIPTION

Pixel EcoFlex 4-in-1 Vertical Bend LED Neon is ideal for creating animated RGB color effects with the look of neon and the benefits of LED lighting. It can be used for a wide variety of creative animations including chasing, rotating graphic patterns, rain effects, color waves, and more. This versatile LED neon product can be used to wrap around three-dimensional objects in applications indoors or outside, including studio sets, signs, stage lighting, and architectural features.

Ideal Application: Ideal for creating animated RGB color effects with the look of neon and the benefits of LED lighting. It can be used for a wide variety of creative animations including chasing, rotating graphic patterns, rain effects, color waves, and more. This versatile LED neon product can be used to wrap around three-dimensional objects in applications indoors or outside, including studio sets, signs, stage lighting, and architectural features.

PRODUCT FEATURES

- Flexible silicone housing, vertical Bend - bends opposite direction of our standard neon product lines
- 4-in-1 (RGB + 3000K, RGB + 6500K, RGBA)
- IC Chip: SM16704
- 1-meter bare wire leads on BOTH ends of each reel
- Solder connection kits, end caps and glue sold separately
- Pixel Addressable
- 120 pixels per reel
- Waterproof, IP65
- Warranty: 3 Year Limited
- Sold in 10 meter reels, 5-meter reels are available upon request

REGULATORY

- UL Listed, RoHS Compliant

TECHNICAL SPECIFICATIONS

Product Number	PLN-ECO-VB-RGBA-10m	PLN-ECO-VB-RGB3000K-10m	PLN-ECO-VB-RGB6500K-10m
Ambient Temperature	-20°C to 50°C	-20°C to 50°C	-20°C to 50°C
Average Lifetime	50,000 Hours	50,000 Hours	50,000 Hours
Beam Angle	120°	120°	120°
Brightness	44/141/32/40 lumens/meter	44/141/32/148 lumens/meter	44/141/32/151 lumens/meter
Color Detail	RGB + Amber	RGB + 3000K White	RGB + 6500K White
Density	84 LEDs/meter	84 LEDs/meter	84 LEDs/meter
Finish	White	White	White
Height	0.63 in [16 mm]	0.63 in [16 mm]	0.63 in [16 mm]
Input Current	4000 mA	4000 mA	4000 mA
Input Voltage	24 DC	24 DC	24 DC
IP Rating	IP65	IP65	IP65
Lead Detail	Bare Wire / 1m [both ends]	Bare Wire / 1m [both ends]	Bare Wire / 1m [both ends]
LED Node Size	5050	5050	5050
Length	32.81 ft [10 m]	32.81 ft [10 m]	32.81 ft [10 m]
Min. Cutting Increment	3.28 in [83.3 mm]	3.28 in [83.3 mm]	3.28 in [83.3 mm]
Power (Watts/ft)	2.9 Watts/ft	2.9 Watts/ft	2.9 Watts/ft
Power (Watts/m)	9.6 Watts/m	9.6 Watts/m	9.6 Watts/m
Regulatory	UL Listed, RoHS	UL Listed, RoHS	UL Listed, RoHS
Warranty	3 years limited	3 years limited	3 years limited
Width	0.63 in [16 mm]	0.63 in [16 mm]	0.63 in [16 mm]

MECHANICAL SPECIFICATIONS

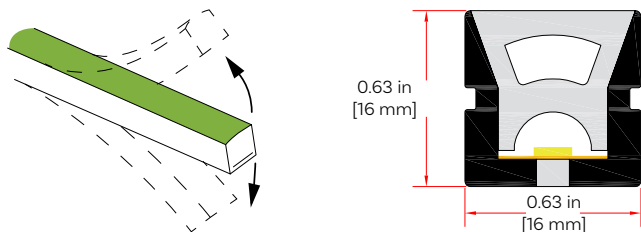

TYPES OF CONNECTOR

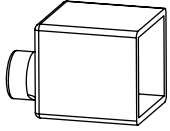
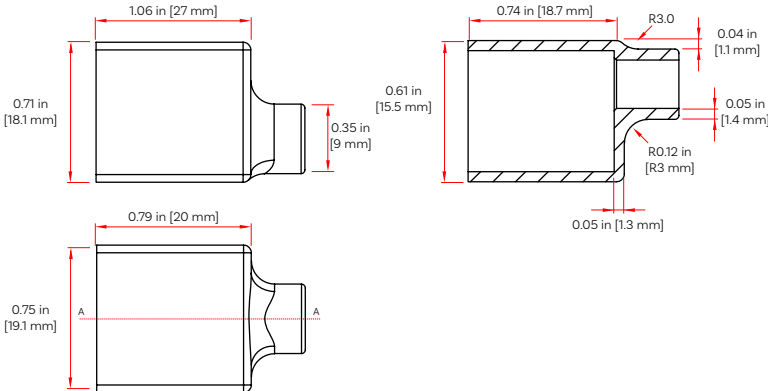
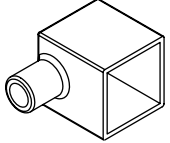
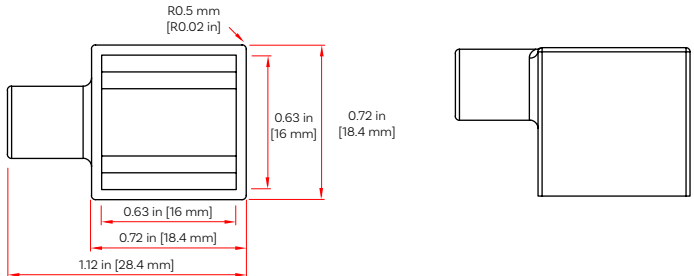

Note: Unless otherwise stated, the tolerance of the connector is ±0.5 mm.

Product	Description	Mechanical Specifications
Straight Exit Solder Connection Kit PLN-ECO-VB-FC 	End cap with front wire exit is compatible with PixelControl EcoFlex 4-in-1 Vertical Bend LED Neon. End cap with wire exit includes 1-meter leads. Glue is sold separately.	
Rear Exit Solder Connection Kit PLN-ECO-VB-RC 	End cap with rear exit wire exit is compatible with PixelControl EcoFlex 4-in-1 Vertical Bend LED Neon. End cap with wire exit includes 1-meter leads. Glue is sold separately.	

MOUNTING PROFILE

STANDARD ALUMINUM PROFILE

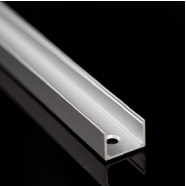
Note: Unless otherwise stated, the tolerance of the connector is ±0.5 mm.

Product	Description	Width	Height	Length
Vertical Bend Mounting Channel LN-ECO-VB-ACH-2m 	Aluminum channel designed for mounting EcoFlex 4-in-1 LED Neon Vertical Bend and holding it in place.	0.71 in [18 mm]	0.47 in [12 mm]	6.56 ft [2 m]
Vertical Bend Mounting Clip LN-ECO-VB-CLIP 	Aluminum clip designed for mounting EcoFlex 4-in-1 LED Neon Vertical Bend and holding it in place. Screw not included.	0.71 in [18 mm]	0.97 in [24.8 mm]	0.1 ft [30.5 mm]