

REVI

Low Voltage Lighting System

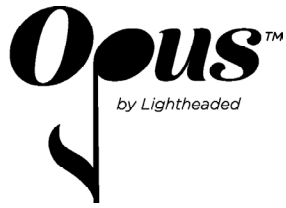

3" | Standard LED | Single Lamp

Change trims, optics and lenses without skipping a beat. Our Opus™ luminaires are an engineering masterpiece. Make changes as quickly as; a-one, and a-two, and a-three.

FIXED DEEP REGRESS



ADJUSTABLE DEEP REGRESS



SHALLOW REGRESS

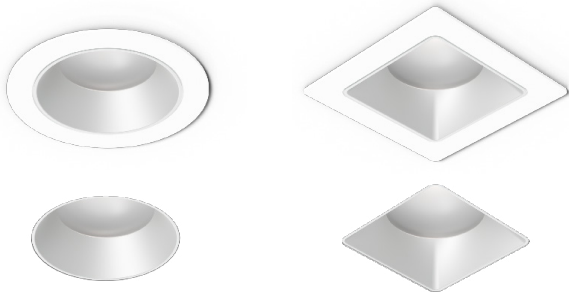

FIXED WALL WASH

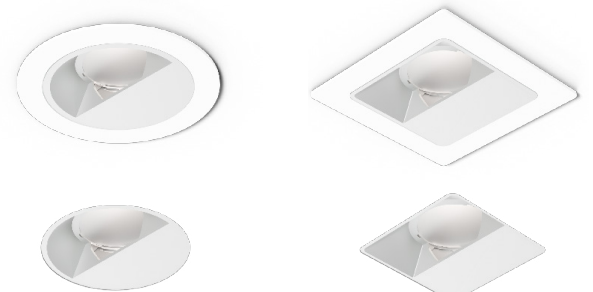

FIXED PINHOLE

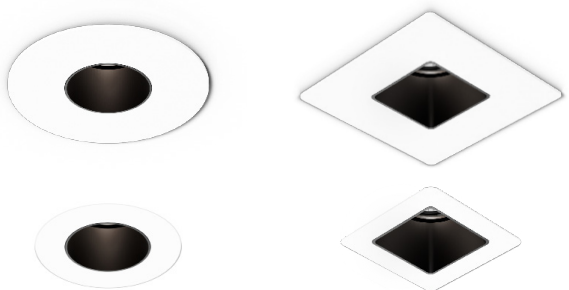

ADJUSTABLE PINHOLE



DECORATIVE

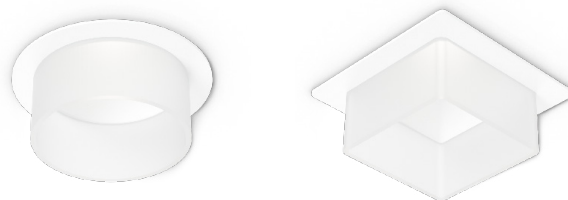

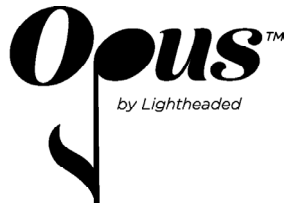

3" | Standard LED | Multiples

Change trims, optics, and lenses without skipping a beat. Our Opus™ luminaires are an engineering masterpiece. make changes as quickly as; a-one, and a-two, and a-three.

FIXED DEEP REGRESS



ADJUSTABLE DEEP REGRESS



SHALLOW REGRESS

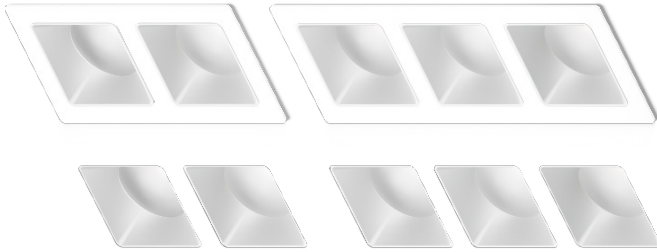

FIXED WALL WASH



FIXED PINHOLE



ADJUSTABLE PINHOLE



OPUS™

3" | Standard LED

RATINGS



California
Title 24 JA8

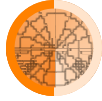

Warm
Dimming



Damp
Location



Wet
Location

CERTIFICATIONS



Intertek



5yr. Warranty

FEATURES

- 3" Aperture
- 2" Aperture (Pinholes)
- Trimmed, Trimless and Wood Trimless options
- Single or multiple lamp options
- 40° Vertical tilt (adjustable trims)
- 361° Rotation (adjustable trims)
- Powder coated trim finishes
- Damp location listed, wet location optional
- Two piece and single piece trims are available w/optional regressed aperture glass lens
- Media holder and clear lens standard with open trim option, optional media available
- Flag style mounting feet, designed for up to 1.25" ceiling thickness standard, optional thick ceiling kit available
- Anodized gold heat sink
- Static CCT and warm dimming available
- Lutron Athena Wireless Node available. Enables individual wireless fixture control
- Emergency Battery option provides 7 watts of emergency power for 90 minutes
- UL2043 Rated enclosures suitable for installation in air handling plenums
- Rated for insulated ceilings to a maximum ambient temperature of 40°C (104°F)
- Rated for non-insulated ceilings to a maximum ambient temperature of 45°C (113°F)

FLANGE & REFLECTOR FINISHES

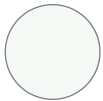

White



Black



Bronze



Matte
Nickel

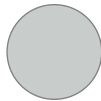

Matte
Silver

COLOR TEMPERATURES



2200K



2700K



3000K



3500K

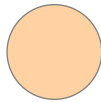

4000K



Warm Dim

BEAM SPREADS



5°



10°



20°



30°



40°



60°



70°



80°



Wall Wash

PERFORMANCE SUMMARY (PER LAMP)

| | | |
|-----------------------|--------|--------|
| Color Accuracy (SDCM) | <3 | |
| L70 Estimate (h) | 50,000 | |
| Color Rendering (CRI) | 80 | 90 |
| Lumen Series (5°) | — | 9002 |
| Delivered Lumens | — | 200 |
| Intensity (cd) | — | 11,000 |
| LED Wattage | — | 8 |
| Lumen Series (5°) | — | 9003 |
| Delivered Lumens | — | 260 |
| Intensity (cd) | — | 14,300 |
| LED Wattage | — | 11 |
| Lumen Series | 8010 | 9008 |
| Source Lumens | 1270 | 1070 |
| Delivered Lumens | 1025 | 875 |
| LED Wattage | 9 | 9 |
| Lumen Series | 8014 | 9010 |
| Source Lumens | 1755 | 1500 |
| Delivered Lumens | 1450 | 1225 |
| LED Wattage | 13 | 13 |
| Lumen Series | 8018 | 9014 |
| Source Lumens | 2450 | 2075 |
| Delivered Lumens | 1975 | 1675 |
| LED Wattage | 18 | 18 |
| Lumen Series | 8023 | 9018 |
| Source Lumens | 3275 | 2750 |
| Delivered Lumens | 2625 | 2225 |
| LED Wattage | 25 | 25 |
| Lumen Series | 8030 | 9023 |
| Source Lumens | 4200 | 3500 |
| Delivered Lumens | 3300 | 2850 |
| LED Wattage | 33 | 33 |

PERFORMANCE SUMMARY (PER LAMP)—WARM DIMMING

| | |
|-----------------------|--------|
| Color Accuracy (SDCM) | <3 |
| L70 Estimate (h) | 50,000 |
| Color Rendering (CRI) | 95 |
| Lumen Series | 9510 |
| Source Lumens | 1000 |
| Delivered Lumens | 925 |
| LED Wattage | 12 |

- Source lumens are based on 3000K color temperature.
- Delivered lumens are based on 3000K color temperature, 40° beam angle and no lens.
- Source & delivered lumens do not apply to 10° beam.
- Refer to IES files for individual product information
- Consult factory for additional lower lumen options.

WARM DIMMING METRICS

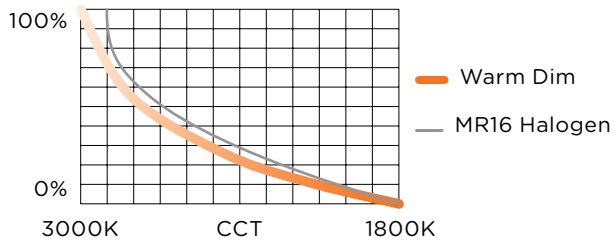

PRODUCT NOTES:

1. Pinhole reflector finish painted O4 black standard.
2. TL flange type only requires flange finish for RP, RPA, SP and SPA trim types.
3. CL & F flush mounted glass is only available with trimmed flange types YA and YF shallow regress and OPEN regress mounted glass option.
4. CC custom color requires factory consultation.
5. O0 Flange and reflector are a single piece and painted one color. Only available with trimmed flange type with RF, RA, RYF, RYA, SF, SYF, SA and SYA trim types.
6. GSL & GFRO glass lens are attached to the regressed trim aperture.
7. T3RWW and T3SWW wall wash trim must be ordered together with WW glass and BWW module beam spread. Not available with 8030 or 9023 lumen series.
8. Field interchangeable beam spread options require consultation with Lighthouse personnel.
9. B05 (5° Beam) is only available with 9002 and 9003 Lumen series with 2700, 3000, 3500 CCT and UNV voltage.
10. B05 (5° Beam) is only available with P1, P0 and D dimming. Not available with EM1 or EM2 options.
11. B10 (10° Beam) is only available with 8010, 9008, 8014 and 9010. Not available in 2200K.
12. 9003 is not available in TL trimless
13. 2200K is only available in 90 CRI.
14. 8023 and 9018 D, LH, PO, P1 only available in Trimmed.
15. Remodel & Remote driver for trimless emergency are not available in 8023, 9018, 8030 & 9023.
16. 8030 and 9023 are only available S and P dimming.
17. 8030 and 9023 are not available with RT remote driver option.
18. Remodel driver included in trim order.
19. Remote driver included with trim order. Wiring between fixture and driver by others.
20. D, P1, P0 and LH dimming is not available with TL trimless flange with 8023, 9018, 8030 & 9023 lumen series.
21. 120 volt is only available in S dimming.
22. UNV volt is only available in P, P1, P0, D & LH dimming.
23. 347 volt is only available in P (0-10V) dimming.
24. 347 volt is not available in Trimless with Remodel driver option.
25. Athena Wireless node is only in P (0-10V) and D (Dali 2) dimming with T (trimmed) flange type.
26. Athena Wireless node is only available in F (non-insulated) housing type. Consult factory for availability with Emergency options EM1 and EM2.
27. EXT extension option is supplied as a kit.
28. Media holder and media are only available with OPEN lens option. Comes standard with clear lens, optional media replaces clear lens when selected.
29. 9002 & 9003 Lumen series are standard with no Optional Media.
30. A1 Decorative acrylic lens is only available with RF & SF fixed trims, T (trimmed) flange & O0 single piece flange finish.
31. EM1 battery option requires R3P-F-RT-EM1 baseplate option.
32. EM1 & EM2 battery are not available in remodel LH dimming.
33. EM1 & EM2 battery are not available in IC or CP with remodel driver.
34. EM1 & EM2 provide 7 watts of emergency power for a minimum of 90 minutes. Not available in 347 volt.
35. EM1 & EM2 battery are not available in 347V
36. Housing can be ordered and shipped prior to luminaire.
37. IC & CP are not available for with 8030, 8023, 9023 or 9018 Lumens Series.
38. IC & CP are UL2043 rated enclosures suitable for installation in air handling plenums.
39. Round & Square trim types utilize the same ceiling cutout shape.
- Wet Location.
- 3000K-1800K Warm Dimming only available in 9510.
- Title 24 JAB qualified, consult factory for complete listing.

SELECT A TRIM

[1] TRIM

- T3RA** Round Adjustable Deep Regress ●
- T3RYA** Round Adjustable Shallow Regress ●
- T3RF** Round Fixed Deep Regress ●
- T3RYF** Round Fixed Shallow Regress ●
- T3RP** Round Pinhole Fixed¹
- T3RPA** Round Pinhole Adjustable¹
- T3RWW** Round Wall Wash⁷
- T3SA** Square Adjustable Deep Regress ●
- T3SYA** Square Adjustable Shallow Regress ●
- T3SF** Square Fixed Deep Regress ●
- T3SYF** Square Fixed Shallow Regress ●
- T3SP** Square Pinhole Fixed¹
- T3SPA** Square Pinhole Adjustable¹
- T3SWW** Square Wall Wash⁷

[2] FLANGE TYPE

- T** Trimmed
- TL** Trimless²

[3] FLUSH MOUNTED GLASS

- [blank]** no lens
- CL** Clear Glass Lens ●³
- F** Frosted Glass Lens ●³

[4] FLANGE FINISH

- 01** White
- 04** Black
- 05** Matte Silver
- 06** Bronze
- 11** Matte Nickel
- CC** Custom Color⁴
- [Blank]** No Flange Finish²

[5] REFLECTOR FINISH

- 00** Single Piece Flange⁵
- 01** White
- 04** Black
- 05** Matte Silver
- 06** Bronze
- 11** Matte Nickel
- CC** Custom Color⁴

[↓] EXCLUDES RP, RPA, SP, SPA TRIMS

- [Blank]** No Reflector Finish

[6] GLASS (MOUNTED TO TRIM)

- OPEN** No Lens
- GSL** Softening ●⁶
- GFRO** Frosted ●⁶
- WW** Wall Wash Trim⁷

[7] MODULE & BEAM SPREAD⁸

- B05** 5° Beam^{9, 10}
- B10** 10° Beam¹¹
- B20** 20° Beam
- B30** 30° Beam
- B40** 40° Beam
- B60** 60° Beam
- B70** 70° Beam
- B80** 80° Beam
- BWW** Wall Wash⁷

[8] COLOR TEMPERATURE

- 22** 2200K¹³
- 27** 2700K
- 30** 3000K
- 35** 3500K
- 40** 4000K
- 3018** 3000K-1800K ●

[9] LUMEN SERIES

- 9002** 90 CRI, 11,000cd⁹
- 9003** 90 CRI, 14,300cd^{9, 10, 12}
- 8010** 80 CRI, 1025lm
- 9008** 90 CRI, 875lm ●
- 8014** 80 CRI, 1450lm
- 9010** 90 CRI, 1225lm ●
- 8018** 80 CRI, 1975lm
- 9014** 90 CRI, 1675lm ●
- 8023** 80 CRI, 2625lm^{14, 15}
- 9018** 90 CRI, 2225lm^{14, 15}
- 8030** 80 CRI, 3300lm^{15, 16, 17}
- 9023** 90 CRI, 2850 lm^{15, 16, 17}
- 9510** 95 CRI, 925lm ●●

[10] DRIVER

- [Blank]** Remodel Driver¹⁸
- RT** Remote Driver¹⁹

[11] DIMMING

- S** Phase Dimming (1%)
- P** 0-10V (1%)
- P1** 0-10V eldoLED ECOdrive (1%)²⁰
- PO** 0-10V eldoLED
- SOLO**drive (0.1%)²⁰
- D** Dali-2 eldoLED ECOdrive (1%)²⁰
- LH** Lutron Hi-lume EcoSystem
- Soft-on** Fade-to-Black (1%)²⁰

[12] VOLTAGE

- 120** 120V²¹
- UNV** 120-277V²²
- 347** 347V^{23, 24}

[13] OPTIONS

- [Blank]** No options
- AW** Lutron Athena Wireless Node RF only^{25, 26}
- EXT** Thick Ceiling (1.25" - 2.0")²⁷

[14] OPTIONAL MEDIA (1 MAX)^{28, 29}

[↓] MOUNTED TO LIGHT ENGINE

- [Blank]** Clear
- SL** Softening
- FRO** Frosted
- HC** Honeycomb
- SPDL** Spread
- EL** Elongating

[15] OPTIONAL ACCESSORIES

- [Blank]** no option
- A1** Decorative frosted acrylic lens - 1.5"³⁰

[16] OPTIONAL EMERGENCY

- EM1** 7 Watt EM Battery w / integral test switch^{31, 32, 33, 34, 35}
- EM2** 7 Watt EM Battery w / remote test switch and cover^{32, 33, 34, 35}

SELECT A HOUSING

[17] HOUSING

- R3P** 3" Baseplate³⁶

[18] CEILING

- F** Non-Insulated
- IC** Insulated Airtight ●^{37, 38}
- CP** Chicago Plenum^{37, 38}

[19] TRIM SHAPE

- R** Round³⁹

[20] FLANGE TYPE

- T** Trimmed & Trimless

[21] OPTIONAL EMERGENCY

- EM1** EM Battery tests switch^{31, 35}

OPUS™

3" | Standard LED | Wood Trimless | Order Form

One driver per lamp

PRODUCT NOTES:

- See table for tilt information.
- Pinhole aperture finish painted 04 black standard.
- CC custom color requires factory consultation.
- GSL & GFRO glass lens are attached to the regressed trim aperture.
- T3RWW and T3SWW wall wash trim must be ordered together with WW glass and BWW module beam spread. Not available with 8030 or 9023 lumen series.
- Field interchangeable beam spread options require consultation with Lighthouse personnel.
- B05 (5° Beam) is only available with 9002 9003 Lumen series with 2700, 3000, 3500 CCT and UNV voltage.
- B05 (5° Beam) is only available with P1, P0 and D dimming. Not available with EM1 or EM2 options.
- B10 (10° Beam) is only available with 8010, 9008, 8014 and 9010. Not available in 2200K.
- 2200K is only available in 90 CRI.
- 8023, 8030, 9018 and 9023 are only available S and P dimming.
- Remodel & Remote driver for trimless emergency are not available in 8023, 9018, 8030 & 9023
- 8030 and 9023 are not available with RT remote driver option.
- Remodel driver included in trim order.
- Remote driver included with trim order. Wiring between fixture and driver by others.
- D, P1, P0 and LH dimming is not available with 8023, 9018, 8030 & 9023 lumen series.
- 120 volt is only available in S dimming.
- UNV volt is only available in P, P1, P0, D & LH dimming.
- 347 volt is only available in P (0-10V) dimming with remote driver option.
- Media holder and media are only available with OPEN lens option. Comes standard with clear lens, optional media replaces clear lens when selected.
- 9002 Lumen series is standard with no Optional Media.
- EM1 battery option requires either R3P-F-RTLW-EM1 or R3P-F-STLW-EM1 baseplate option.
- EM1 & EM2 battery are not available in remodel LH dimming.
- EM1 & EM2 battery are not available in IC or CP with remodel driver.
- EM1 & EM2 provide 7 watts of emergency power for a minimum of 90 minutes.
- EM1 & EM2 battery are not available in 347V
- Housing can be ordered and shipped prior to luminaire.
- IC & CP are not available for with 8030, 8023, 9023 or 9018 Lumen Series.
- IC & CP are UL2043 rated enclosures suitable for installation in air handling plenums.
- Housing shape must match trim shape.
- 3000K-1800K Warm Dimming only available in 9510.
- Title 24 JA8 qualified, consult factory for complete listing.

SELECT A TRIM

[1] TRIM

- T3RA** Round Adjustable Deep Regress ●¹
- T3RYA** Round Adjustable Shallow Regress ●¹
- T3RF** Round Fixed Deep Regress ●
- T3RYF** Round Fixed Shallow Regress ●
- T3RP** Round Pinhole Fixed²
- T3RPA** Round Pinhole Adjustable^{1,2}
- T3RWW** Round Wall Wash⁵
- T3SA** Square Adjustable Deep Regress ●¹
- T3SYA** Square Adjustable Shallow Regress ●¹
- T3SF** Square Fixed Deep Regress ●
- T3SYF** Square Fixed Shallow Regress ●
- T3SP** Square Pinhole Fixed²
- T3SPA** Square Pinhole Adjustable^{1,2}
- T3SWW** Square Wall Wash⁵

[2] FLANGE TYPE

- TLW** Wood Trimless

[3] FINISH

- 01** White
- 04** Black
- 05** Matte Silver
- 06** Bronze
- 11** Matte Nickel
- CC** Custom Color³

[4] GLASS (MOUNTED TO TRIM)

- OPEN** No Lens
- GSL** Softening ●⁴
- GFRO** Frosted ●⁴
- WW** Wall Wash⁵

[5] MODULE & BEAM SPREAD⁶

- B05** 5° Beam^{7,8}
- B10** 10° Beam⁹
- B20** 20° Beam
- B30** 30° Beam
- B40** 40° Beam
- B60** 60° Beam
- B70** 70° Beam
- B80** 80° Beam
- WW** Wall Wash⁵

[6] COLOR TEMPERATURE

- 22** 2200K¹⁰
- 27** 2700K
- 30** 3000K
- 35** 3500K
- 40** 4000K
- 3018** 3000K-1800K ●

[7] LUMEN SERIES

- 9002** 90 CRI, 11,000cd^{7,8}
- 8010** 80 CRI, 1025lm
- 9008** 90 CRI, 875lm ●
- 8014** 80 CRI, 1450lm
- 9010** 90 CRI, 1225lm ●
- 8018** 80 CRI, 1975lm
- 9014** 90 CRI, 1675lm ●
- 8023** 80 CRI, 2625lm^{11,12}
- 9018** 90 CRI, 2225lm^{11,12}
- 8030** 80 CRI, 3300lm^{12,13}
- 9023** 90 CRI, 2850 lm^{12,13}
- 9510** 95 CRI, 925lm ●●

[8] DRIVER

- [Blank]** Remodel Driver¹⁴
- RT** Remote Driver¹⁵

[9] DIMMING

- S** Phase Dimming (1%)
- P** 0-10V (1%)
- P1** 0-10V eldoLED ECOdrive (1%)¹⁶
- PO** 0-10V eldoLED SOLOdrive (0.1%)¹⁶
- D** Dali-2 eldoLED ECOdrive (1%)¹⁶
- LH** Lutron Hi-lume EcoSystem
- Soft-on Fade-to-Black (1%)¹⁶

[10] VOLTAGE

- 120** 120V¹⁷
- UNV** 120-277V¹⁸
- 347** 347V¹⁹

[11] CEILING THICKNESS

- 1** 0.5" to 0.75" Ceiling thickness¹
- 2** 0.75" to 1.0" Ceiling thickness¹
- 3** 1.0" to 1.25" Ceiling thickness¹
- 4** 1.25" to 2.5" Ceiling thickness¹

[12] OPTIONAL MEDIA (1 MAX)^{20, 21}

⌵ MOUNTED TO LIGHT ENGINE

- [Blank]** Clear
- SL** Softening
- FRO** Frosted
- HC** Honeycomb
- SPDL** Spread
- EL** Elongating

[13] OPTIONAL EMERGENCY

- EM1** 7 Watt EM Battery w / integral test switch^{22, 23, 24, 25, 26}
- EM2** 7 Watt EM Battery w / remote test switch and cover^{23, 24, 25, 26}

SELECT A HOUSING

[14] HOUSING

- R3P** 3" Baseplate²⁷

[15] CEILING

- F** Non-Insulated
- IC** Insulated Airtight ●^{28, 29}
- CP** Chicago Plenum^{28, 29}

[16] TRIM SHAPE

- R** Round²⁸
- S** Square²⁸

[17] FLANGE TYPE

- TLW** Wood Trimless

[18] OPTIONAL EMERGENCY

- EM1** EM Battery tests switch^{22, 26}

OPUS™

3" | Standard LED | Multiples | Trimmed & Trimless | Order Form

One driver per lamp

PRODUCT NOTES:

1. Consult factory for additional combinations.
2. Pinhole reflector finish painted O4 black standard.
3. Trim layout must match housing layout.
4. TL flange type only requires flange finish for SP and SPA trim types.
5. CC custom color requires factory consultation.
6. GSL & GFRO glass lens are attached to the regressed trim aperture.
7. T3SWW wall wash trim must be ordered together with WW glass and BWW module beam spread.
8. Field interchangeable beam spread options require consultation with Lighthouse personnel.
9. B05 (5° Beam) is only available with 9002 and 9003 Lumen series with 2700, 3000, 3500 CCT and UNV voltage.
10. B05 (5° Beam) is only available with P1, P0 and D dimming. Not available with EM1 or EM2 options.
11. B10 (10° Beam) is only available with 8010, 9008, 8014 and 9010. Not available in 2200K.

12. 2200K is only available in 90 CRI.
 13. 9003 is not available in TL trimless.
 14. Remodel drivers included in trim order.
 15. Remote drivers included with trim order. Wiring between fixture and driver by others.
 16. 120 volt is only available in S dimming.
 17. UNV volt is only available in P, P1, P0, D & LH dimming.
 18. 347V is only available in P (0-10V) dimming and T (trimmed) flange types.
 19. 347 volt is not available in Trimless with Remodel driver option.
 20. Media holder and media are only available with OPEN lens option. Comes standard with clear lens, optional media replaces clear lens when selected.
 21. 9002 & 9003 Lumen series are standard with no Optional Media.
 22. Housing can be ordered and shipped prior to luminaire.
- Wet Location.
● 3000K-1800K Warm Dimming only available in 9510.

SELECT A TRIM

[1] TRIM¹

- T3SA** Square Adjustable Deep Regress
- T3SYA** Square Adjustable Shallow Regress
- T3SF** Square Fixed Deep Regress
- T3SYF** Square Fixed Shallow Regress
- T3SP** Square Pinhole Fixed²
- T3SPA** Square Pinhole Adjustable²
- T3SWW** Square Wall Wash⁷

[2] LAYOUT³

- 2** 1x2 Multiple
- 3** 1x3 Multiple

[3] FLANGE TYPE

- T** Trimmed
- TL** Trimless⁴

[4] FLANGE FINISH

- 01** White
- 04** Black
- 05** Matte Silver
- 06** Bronze
- 11** Matte Nickel
- CC** Custom Color⁵
- [Blank]** No Flange Finish⁴



[5] REFLECTOR FINISH

- 01** White
- 04** Black
- 05** Matte Silver
- 06** Bronze
- 11** Matte Nickel
- CC** Custom Color⁵

[↕] EXCLUDES SP, SPA TRIMS

- [Blank]** No Reflector Finish

[6] GLASS (MOUNTED TO TRIM)

- OPEN** No Lens
- GSL** Softening ⁶
- GFRO** Frosted ⁶
- WW** Wall Wash⁷

[7] MODULE & BEAM SPREAD⁸

- B05** 5° Beam^{9,10}
- B10** 10° Beam⁹
- B20** 20° Beam
- B30** 30° Beam
- B40** 40° Beam
- B60** 60° Beam
- B70** 70° Beam
- B80** 80° Beam
- BWW** Wall Wash⁷

[8] COLOR TEMPERATURE

- 22** 2200K¹²
- 27** 2700K
- 30** 3000K
- 35** 3500K
- 40** 4000K
- 3018** 3000K-1800K 

[9] LUMEN SERIES

- 9002** 90 CRI, 11,000cd^{9,10}
- 9003** 90 CRI, 14,300cd^{9,10,13}
- 8010** 80 CRI, 1025lm
- 9008** 90 CRI, 875lm
- 8014** 80 CRI, 1450lm
- 9010** 90 CRI, 1255lm
- 8018** 80 CRI, 1975lm
- 9014** 90 CRI, 1675lm
- 9510** 95 CRI, 925lm 

[10] DIMMING

- [blank]** Remodel Driver¹⁴
- RT** Remote Driver¹⁵

[11] DIMMING

- S** Phase Dimming (1%)
- P** 0-10V (1%)
- P1** 0-10V eldoLED ECOdrive (1%)
- PO** 0-10V eldoLED SOLOdrive (0.1%)
- D** Dali-2 eldoLED ECOdrive (1%)
- LH** Lutron Hi-lume EcoSystem Soft-on Fade-to-Black (1%)

[12] VOLTAGE

- 120** 120V¹⁶
- UNV** 120-277V¹⁷
- 347** 347V^{18,19}

[13] OPTIONAL MEDIA (1 MAX)^{20,21}

[↕] MOUNTED TO LIGHT ENGINE

- [Blank]** Clear
- SL** Softening
- FRO** Frosted
- HC** Honeycomb
- SPDL** Spread
- EL** Elongating

SELECT A HOUSING

[14] HOUSING

- R3P** 3" Baseplate²²

[15] CEILING

- F** Non-Insulated

[16] TRIM SHAPE

- S** Square

[17] LAYOUT³

- 2** 1x2 Multiple
- 3** 1x3 Multiple

[18] FLANGE TYPE

- T** Trimmed & Trimless

CEILING CUTOUTS

TRIMMED /TRIMLESS ROUND

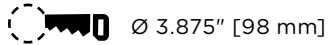

WOOD TRIMLESS ROUND

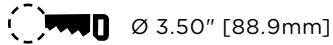

TRIMMED /TRIMLESS SQUARE

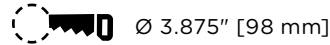

WOOD TRIMLESS SQUARE

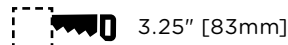

ROUND SINGLE DIMENSIONS

ADJUSTABLE DEEP REGRESS

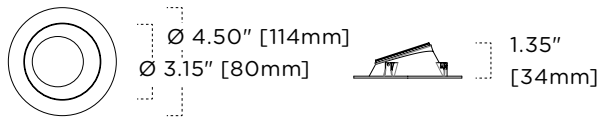

FIXED DEEP REGRESS

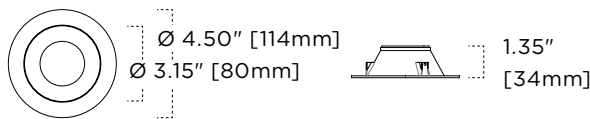

FIXED WALL WASH

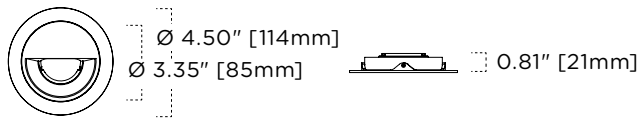

FIXED SHALLOW REGRESS

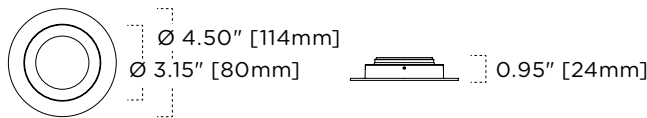

ADJUSTABLE PINHOLE

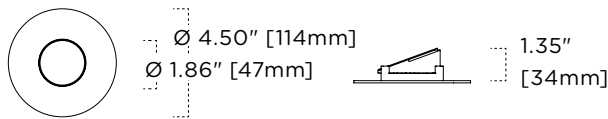

FIXED PINHOLE

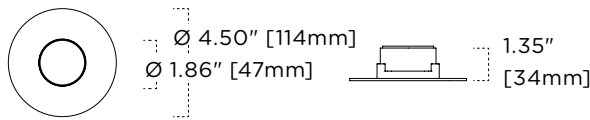

DECORATIVE



TRIMLESS/WOOD TRIMLESS ROUND SINGLE DIMENSIONS

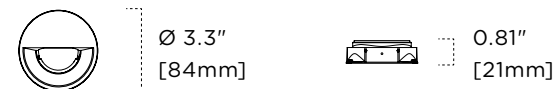
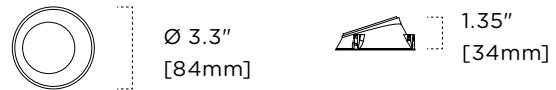

SQUARE SINGLE DIMENSIONS

ADJUSTABLE DEEP REGRESS

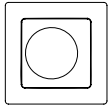

4.25" [108mm]
2.86" [73mm]

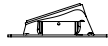

1.35"
[34mm]



3.03"
[77mm]



1.35"
[34mm]

FIXED DEEP REGRESS

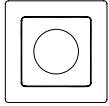

4.25" [108mm]
2.9" [74mm]



1.26"
[32mm]



3.03"
[77mm]



1.26"
[32mm]

FIXED WALL WASH

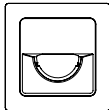

Ø 4.25" [108mm]
Ø 3.04" [77mm]



0.81" [21mm]



3.03"
[77mm]



0.81"
[21mm]

FIXED SHALLOW REGRESS

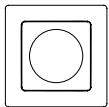

4.25" [108mm]
2.9" [74mm]



0.95" [24mm]



3.03"
[77mm]



0.95"
[24mm]

ADJUSTABLE PINHOLE

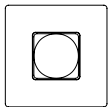

4.24"
[108mm]

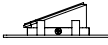

1.26"
[32mm]



3.03"
[77mm]



1.26"
[32mm]

FIXED PINHOLE

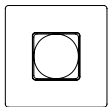

4.24"
[108mm]

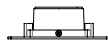

1.26"
[32mm]



3.03"
[77mm]



1.26"
[32mm]

DECORATIVE

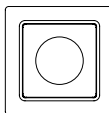

4.24"
[108mm]

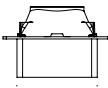

1.35"
[34mm]
1.5"
[38mm]
3.14" [80mm]

1X2 MULTIPLE DIMENSIONS

ADJUSTABLE DEEP REGRESS

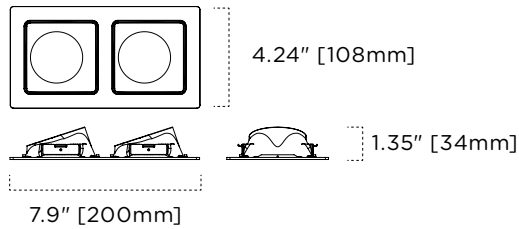

FIXED DEEP REGRESS

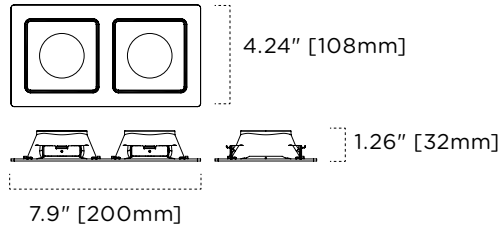

FIXED WALL WASH

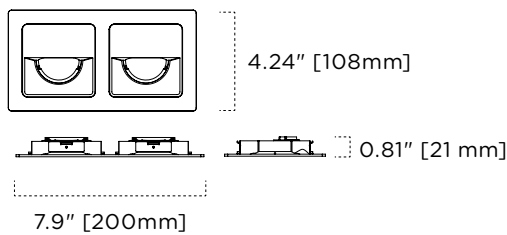

FIXED SHALLOW REGRESS

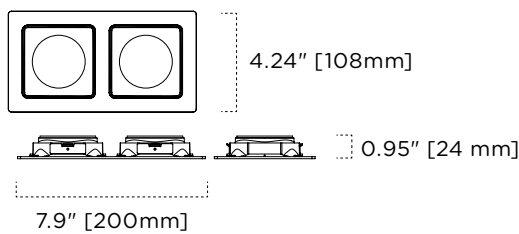

ADJUSTABLE PINHOLE

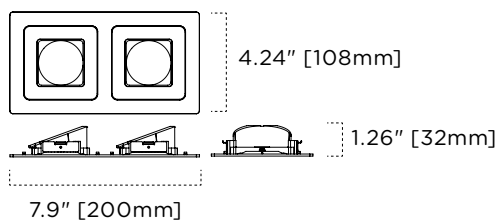

FIXED PINHOLE

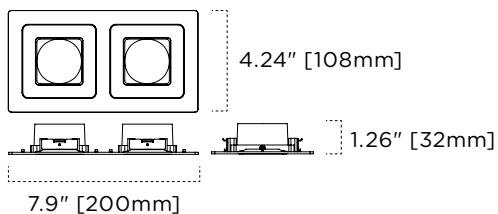

1X2 TRIMLESS MULTIPLE DIMENSIONS

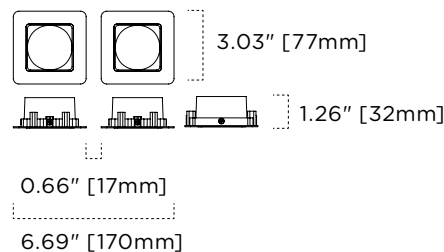
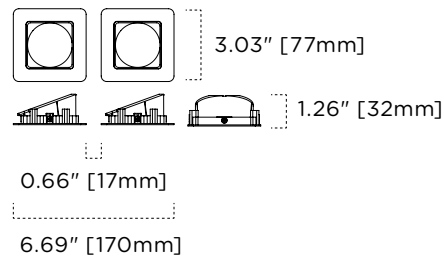
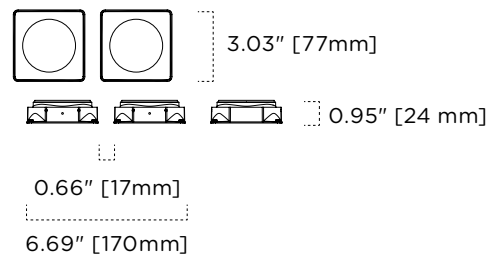
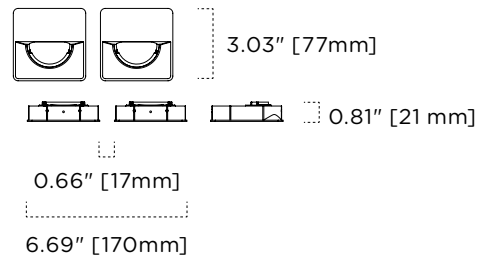
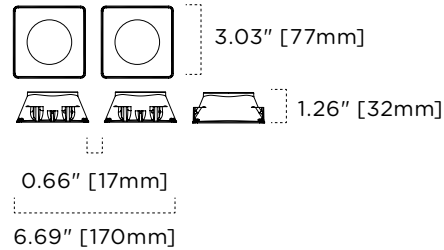
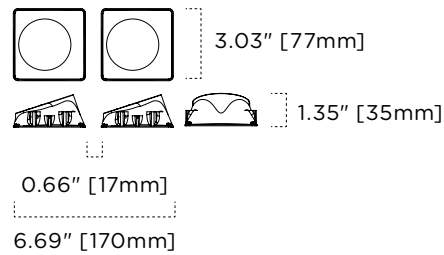

1X3 MULTIPLE DIMENSIONS

ADJUSTABLE DEEP REGRESS

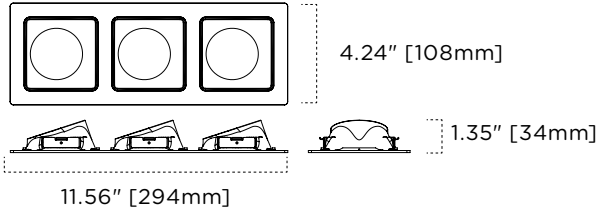

FIXED DEEP REGRESS

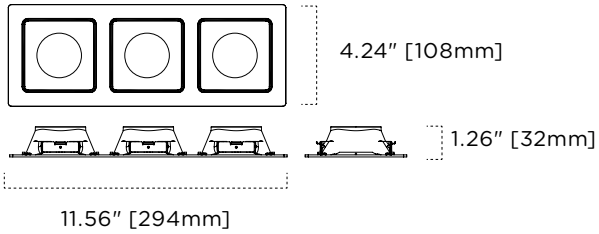

FIXED WALL WASH

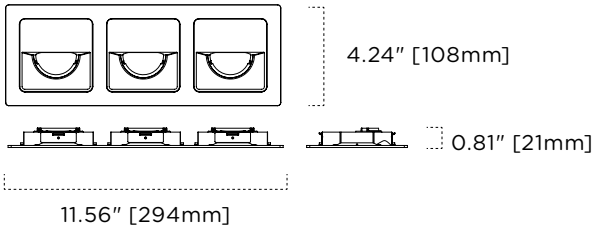

FIXED SHALLOW REGRESS

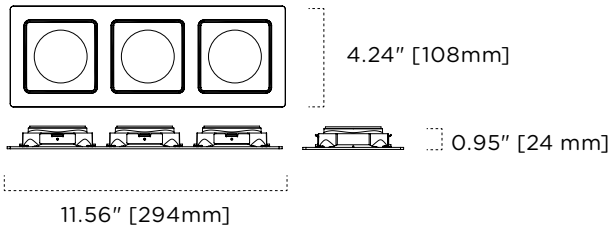

ADJUSTABLE PINHOLE

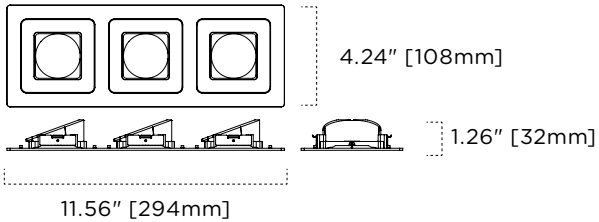

FIXED PINHOLE

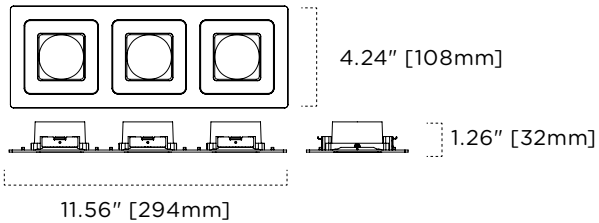

1X3 TRIMLESS MULTIPLE DIMENSIONS

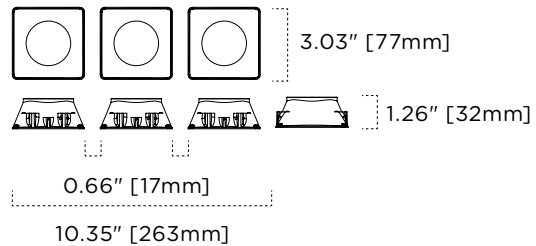
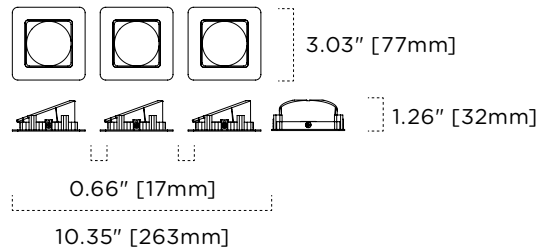
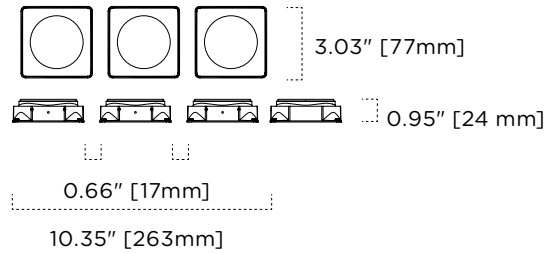
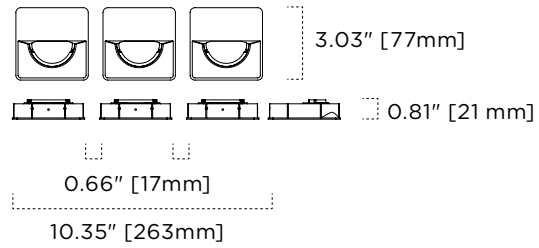
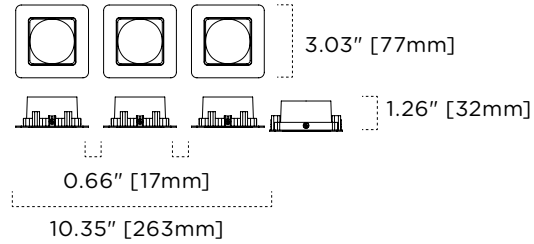
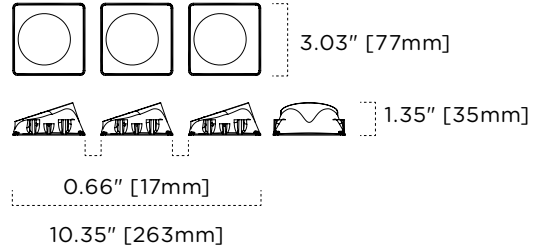

LIGHT ENGINE DIMENSIONS

FIXED & WALL WASH TRIM & TRIMLESS

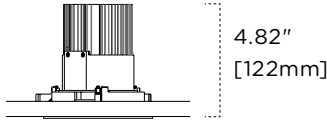

ADJUSTABLE TRIM & TRIMLESS

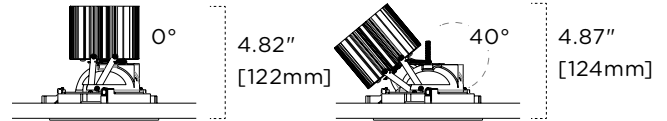

FIXED & WALL WASH WOOD TRIMLESS

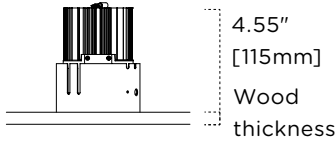

ADJUSTABLE WOOD TRIMLESS



ADJUSTABLE ROUND/SQUARE WOOD TRIMLESS VARIANCES ON TILT WITH WOOD CEILING THICKNESS

| Ceiling thickness (Inches) | Round Maximum tilt (Degree) | Square Maximum tilt (Degree) |
|----------------------------|-----------------------------|------------------------------|
| 0.50 | 30 | 20 |
| 0.75 | 30 | 20 |
| 1.00 | 24 | 15 |
| 1.25 | 20 | 13 |
| 1.50 | 10 | 9 |
| 1.75 | 9 | 9 |
| 2.0 | 9 | 9 |
| 2.25 | 8 | 9 |
| 2.5 | 7 | 9 |

NON-INSULATED (F)—ROUND & SQUARE SINGLE TRIM HOUSING DIMENSIONS

TRIMMED / TRIMLESS

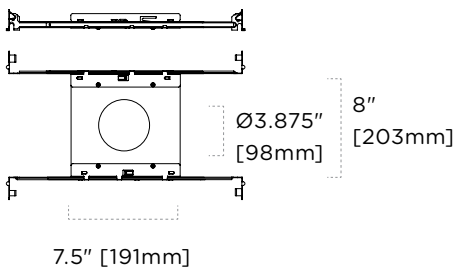

ROUND WOOD TRIMLESS

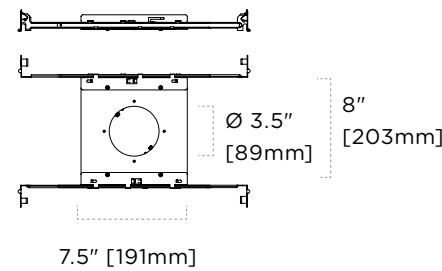

SQUARE WOOD TRIMLESS

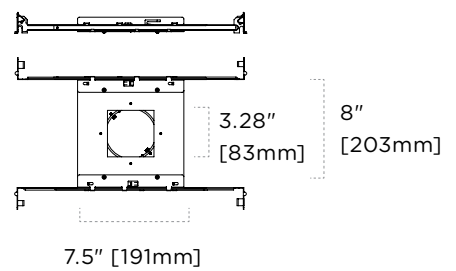

NON-INSULATED (F)—ROUND & SQUARE SINGLE TRIM HOUSING DIMENSIONS (EM1)

TRIMMED / TRIMLESS

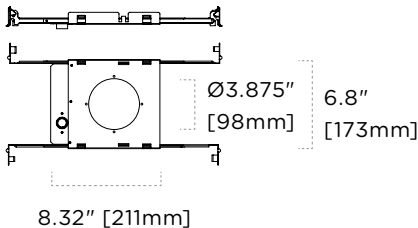

ROUND WOOD TRIMLESS

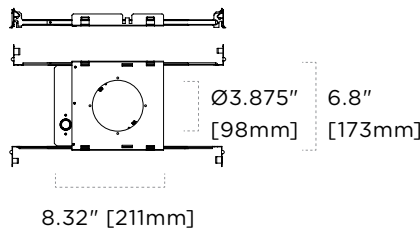

SQUARE WOOD TRIMLESS

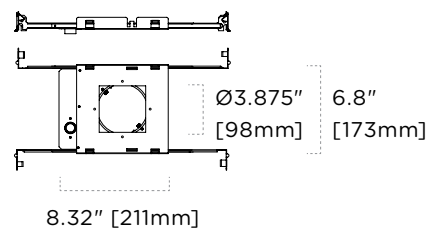

NON-IC HOUSINGS REMOTE TEST COVER DIMENSIONS (EM2)

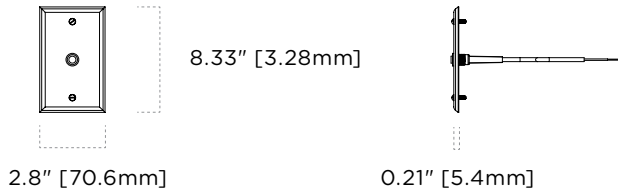

NON-INSULATED (F)—ROUND & SQUARE MULTIPLES TRIM HOUSING DIMENSIONS

TRIMMED / TRIMLESS (1X2)

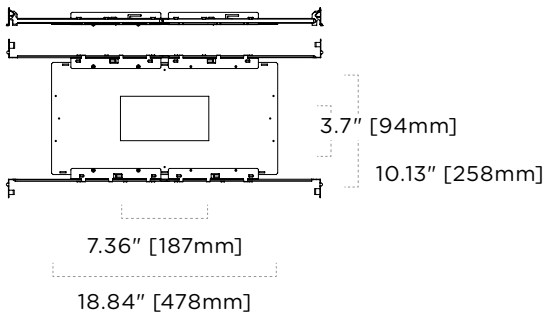

TRIMMED / TRIMLESS (1X3)

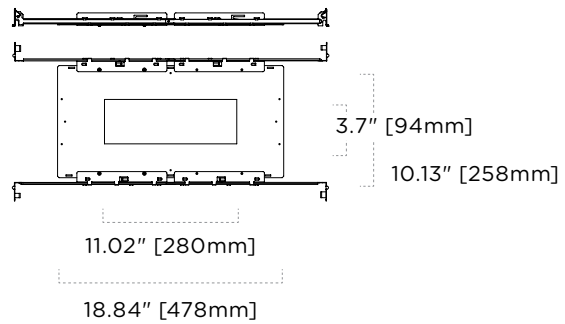

INSULATED AIRTIGHT (IC)—ROUND & SQUARE HOUSING DIMENSIONS

TRIMMED / TRIMLESS

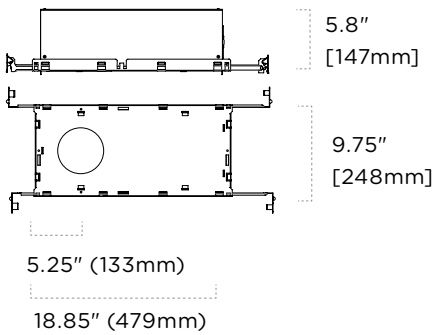

ROUND WOOD TRIMLESS

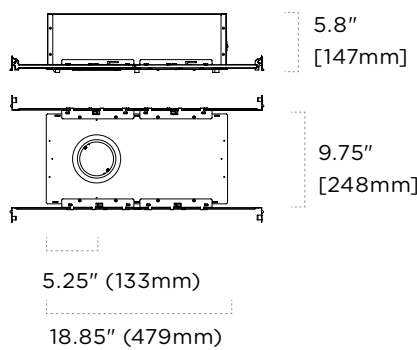

SQUARE WOOD TRIMLESS

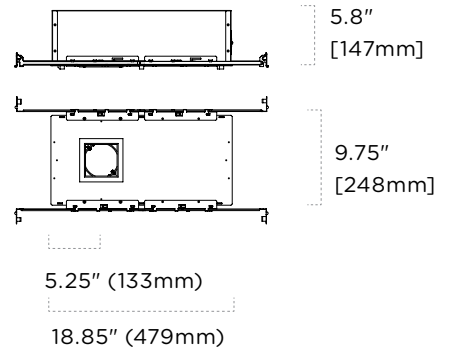

CHICAGO PLENUM (CP) —ROUND & SQUARE HOUSING DIMENSIONS

TRIMMED / TRIMLESS

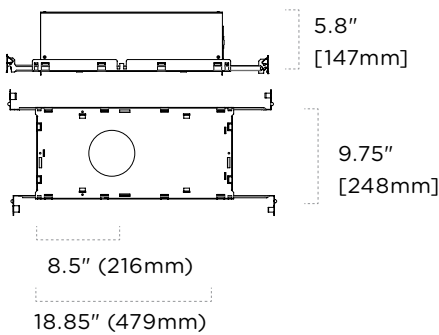

ROUND WOOD TRIMLESS

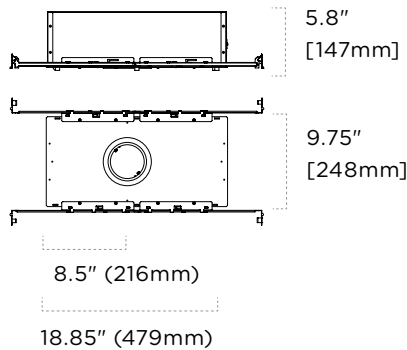

SQUARE WOOD TRIMLESS

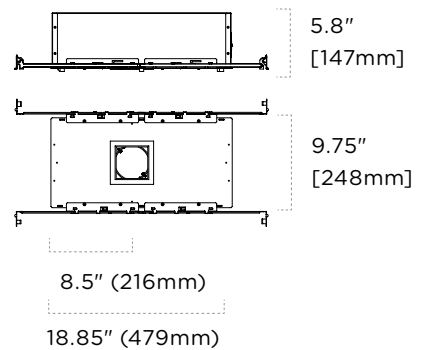

DRIVER DIMENSIONS

Minimum Required Plenum Height 5.5" [140mm] for 0.5" [13mm] to 1.0" [25mm] thick ceilings.

TRIMMED REMODEL DRIVER

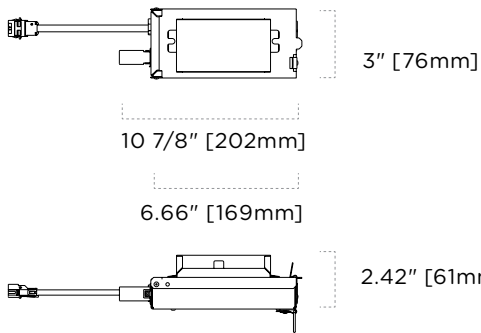

TRIMLESS / WOOD TRIMLESS REMODEL DRIVER

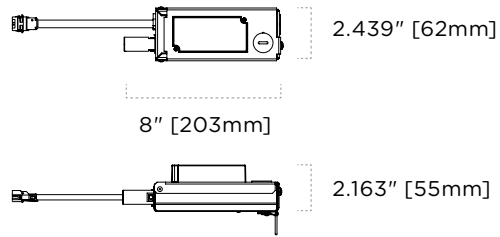

TRIMMED REMODEL DRIVER (EM)

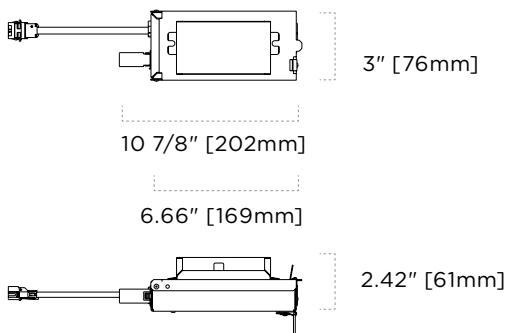

TRIMLESS / WOOD REMODEL DRIVER (EM)

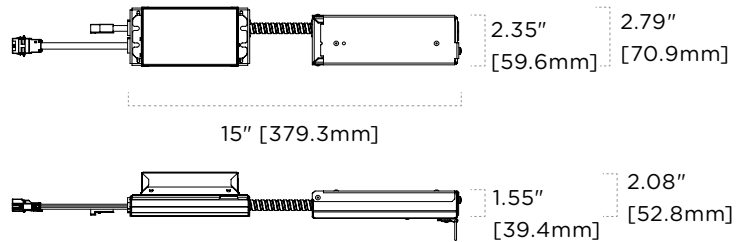

REMOTE DRIVER DIMENSIONS

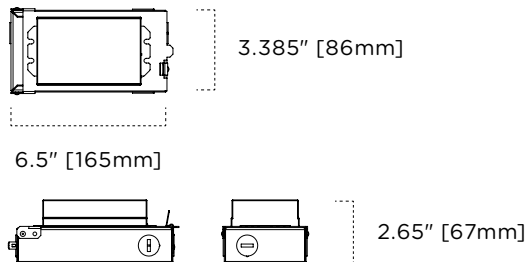

*Maximum remote mounting distance (Wire length).

1. LH : 100' using 12 AWG, 50' using 14 AWG.
2. P, P1, PO, D, S : 100' using 14 AWG, 50' using 16 AWG.
3. Remote driver included in trim part number.